

Implementation and Tuning Guideline for FCR provision

Nordic Analysis Group

2023-05-29

Author:

Linn Saarinen Svenska kraftnät

Contents

Abbreviations and symbols.....	3
1 Introduction	4
1.1 Typical controllers and basic model.....	5
2 Stability.....	6
2.1 Ideal case – directly proportional control.....	6
2.2 Typical case – PI controller with droop	9
3 Performance.....	12
4 Droop.....	14
4.1 Typical problems at high droop	16
4.2 Typical problems at low droop.....	17
5 Feedback signal	19
6 A model-based approach to controller tuning	21
7 Equipment.....	21
8 Appendix	22
8.1 Explanation of the performance requirement.....	22

Abbreviations and symbols

Abbreviations

FCR Frequency containment reserve

PI Proportional-integral

Symbols

E_p Droop of the controller

H Inertial time constant

K_i Integral gain of the controller

K_p Proportional gain of the controller

M_s Stability margin

s Laplace operator

T_{feedback} Feedback time constant of the controller

Y Actuator position, e.g. guide vane opening

1 Introduction

The technical requirements for Frequency Containment Reserves (FCR) have been designed such as to not state what type of controller or what type of technology behind the controller should be used for delivering FCR. The intention has been that the requirements should be technology neutral, applicable for different kinds of technologies, and leave suitable room for different controller implementations. This tuning guideline describes general tuning principles and trade-offs between performance and stability. A hydropower unit with a PI controller with droop is used as an example throughout the text, since this is the most common FCR providing unit in the Nordic system today. However, many of the considerations should be applicable also for providers with different controllers or different technology behind the controller.

The introduction describes the models used in the analysis: A power system model, some typical controller structures including the concept of “feedback time constant” and the hydropower model which is used as an example. The second chapter discusses the stability requirement. First, an ideal case with strictly proportional controller is introduced. It is showed why a proportional controller will not give sufficient stability margins if the controlled resource has a slow response. Then, stability considerations when using with PI controller with droop are described. The third chapter discusses the performance requirement and how the selection of PI parameters can impact the performance. The fourth chapter describes how the droop can impact the performance and stability due to non-linear behavior. The fifth chapter discusses the selection of feedback signal, i.e. actuator feedback or power feedback. The sixth chapter outlines a model-based approach to governor tuning, which utilizes preliminary test results in combination with a model of the controller to check if new controller parameters are likely to make the unit fulfill the requirements.

Figure 1 shows a block diagram of a simplified power system with primary frequency control from FCR. Here, all the units providing FCR are lumped into one unit with a governor (controller) F_{gov} and a controllable power source G_{unit} . The lumped FCR unit feeds power to the power system G_{sys} , which is the lumped inertia and damping of all the units connected to the system. Variations in production and load, $\Delta P_{disturbance}$ enters the system at the same point as the FCR power. Note that with the notation in the Technical requirements, the transfer function of an FCR providing unit from frequency deviation to power output is $F(s) = F_{gov}(s)G_{unit}(s)$. The power system transfer function $G(s) = G_{sys}(s)$.

The technical requirements for FCR are defined in terms of this model. In the analysis of stability and performance, the response from the tested unit is scaled so that it represents the full FCR volume of the Nordic system. This means that each unit should act in such a way that if all units acted in this particular way, the system would be stable and frequency variations would be contained within specified limits.

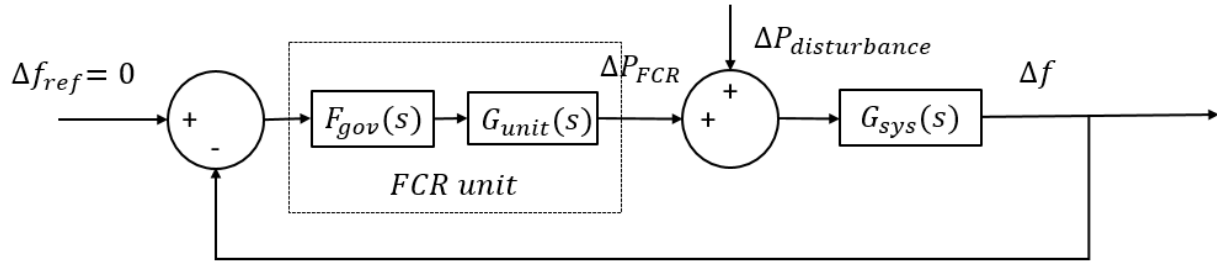

Figure 1. Block diagram of a simplified power system with primary frequency control from frequency containment reserves, FCR.

1.1 Typical controllers and basic model

The controller considered in this tuning guideline is an *independent form PI controller with droop* as shown in Figure 2. Some PI-controllers are instead implemented on dependent form, as shown in Figure 3. In both cases, the proportional gain of the controller is determined by the parameter K_p .

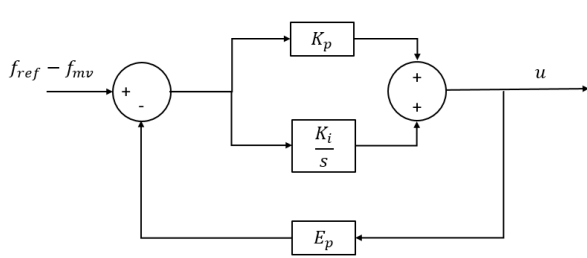

Figure 2. PI-controller with droop, independent form.

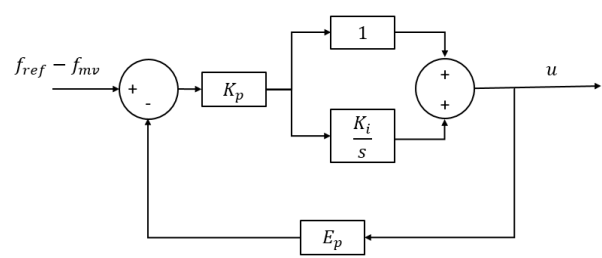

Figure 3. PI-controller with droop, dependent form.

The feedback time constant of the controller is a useful concept. Here, we define the feedback time constant as the time it takes for a step response to reach 63% of the final value, if the proportional path of the controller is neglected. With this definition, the independent form PI controller with droop, the feedback time constant is

$$T_{feedback} = \frac{1}{K_i E_p} \quad 1.1$$

and the feedback time constant for the dependent form PI controller with droop is

$$T_{feedback} = \frac{1}{K_p K_i E_p}. \quad 1.2$$

Neglecting the proportional part is reasonable as long as it is relatively small compared to the steady state response. The step response with $K_p = 0$ and $K_p = 5$ are compared in Figure 4 and Figure 5. The feedback time constant according to Equation 1.1 is marked with a star. The step

response is slightly faster than the thus defined feedback time constant when $K_p = 5$. For higher proportional parts, the difference increases.

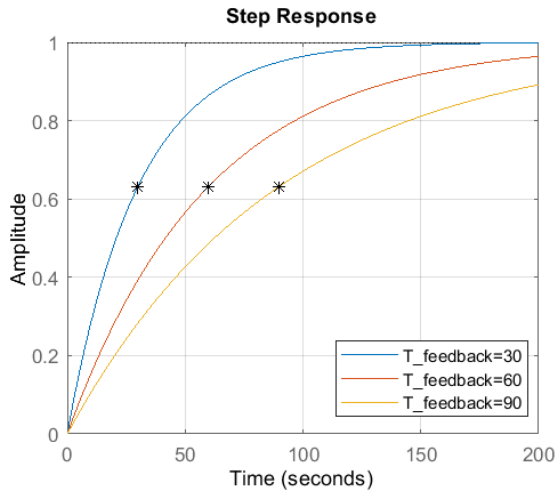

Figure 4. Step response of the independent form PI controller with droop, with $E_p=0.04$, $K_p=0$.

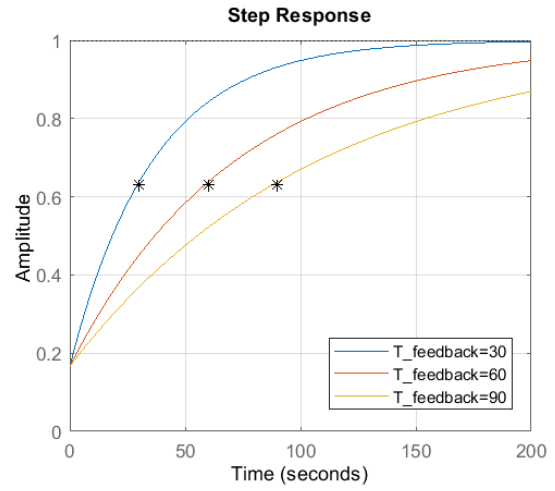

Figure 5. Step response independent form PI controller with droop, with $E_p=0.04$, $K_p=5$.

The PI-controller with droop on independent form shown in Figure 2 has the transfer function

$$F_{gov}(s) = \frac{K_p s + K_i}{(E_p K_p + 1)s + E_p K_i} \quad 1-3$$

The power source used as an example in this guideline is a hydropower unit modelled with the simple linearized model

$$G_{unit}(s) = \frac{-T_w s + 1}{0.5 T_w s + 1} \quad 1-4$$

If not stated otherwise, the water time constant $T_w = 1.5$ is used in the following analysis.

2 Stability

2.1 Ideal case – directly proportional control

The power system model, G_{sys} in Figure 1, can be expressed by the transfer function $G_{sys}(s) = \frac{1}{2Hs+D}$ or as a negative feedback on an integrating system, as detailed in

Figure 6. A change in the balance of production and consumption results in a frequency change, and the rate of change depends on the size of the imbalance and the inertia constant, H . The system also has some damping, which can be represented as a proportional negative feedback with

the gain D . The purpose of FCR is to increase the negative feedback, that is, to increase D . However, any control system that in practice attempts to be directly proportional would have some sort of delay or other dynamical behavior, represented by e^{-sT} in Figure 7. If the delay is too large, the system will become unstable.

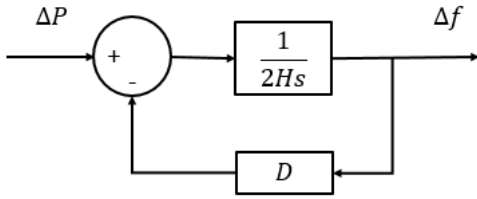

Figure 6. Block diagram of a simplified model of the power system with inertia H and damping D .

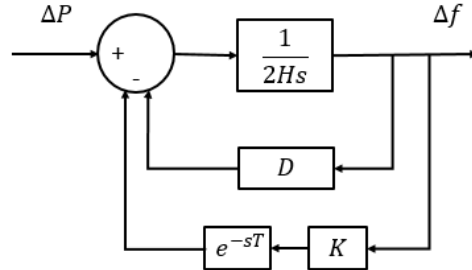

Figure 7. A control loop with proportional control with the regulating strength K and time delay T is added to the system in

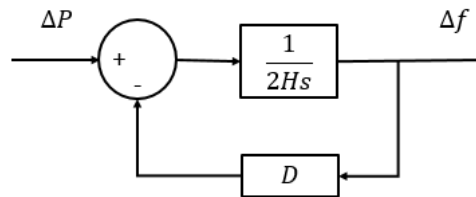

Figure 6.

Figure 8 shows the Bode diagram of the system depicted in

Figure 6 with parameters H and D set according to the technical requirements for the performance and stability requirement of FCR-N and FCR-D respectively. The phase plot also shows the *delay margin* of each system. The delay margin is the maximal delay the feedback loop can have without making the system unstable, if the gain of the loop, K , is equal to one. The delay margin of the FCR-N stability requirement is 1.3 seconds.

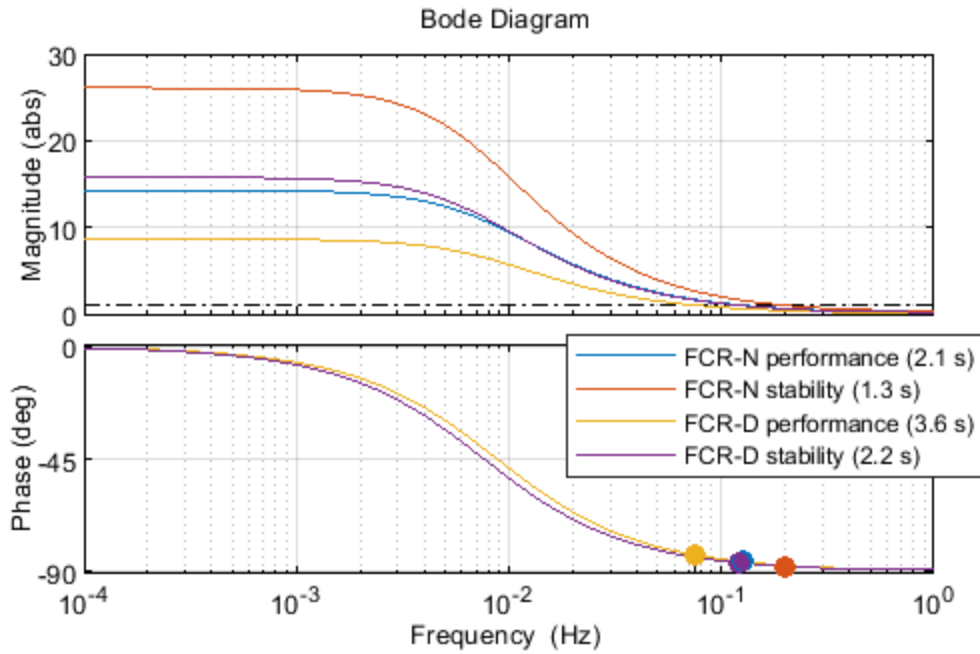

Figure 8. Bode diagram with delay margin for the power system model used for the stability and performance criteria for FCR-N and FCR-D. The delay margins are given within parenthesis in the figure legend.

The stability requirements for FCR-N and FCR-D states not only that the feedback system has to be stable, but also specifies a required stability margin ($M_s = 3.21$, i.e. the Nyquist curve has to pass to the right of the point $-1,0j$ at a minimal distance of $\frac{1}{M_s} = 0.43$). This is illustrated in Figure 9, where the required margin is shown as a black circle around the point $(-1,0j)$ in the complex plane. The blue curve corresponds to the FCR-N system without delay. The system with 1.29 s delay (equal to the delay margin) crosses the x-axis at -1 , i.e. it is on the stability limit. To have a sufficient stability margin, the maximal delay is 0.67 s (red curve). Figure 10 shows the same for the FCR-D system.

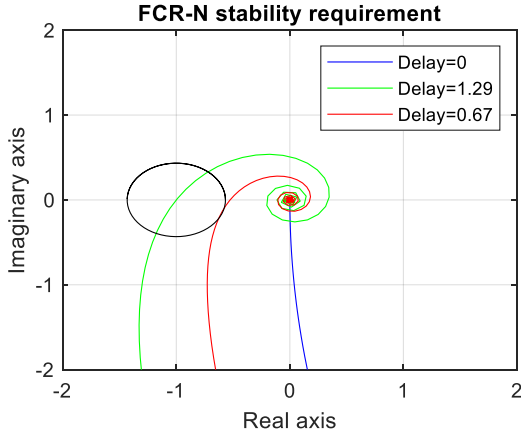

Figure 9. The blue curve shows the Nyquist curve of the FCR-N system without delay, the green curve shows the system with delay corresponding to the delay margin, and the red curve shows the system with the maximal delay that fulfills the stability margin.

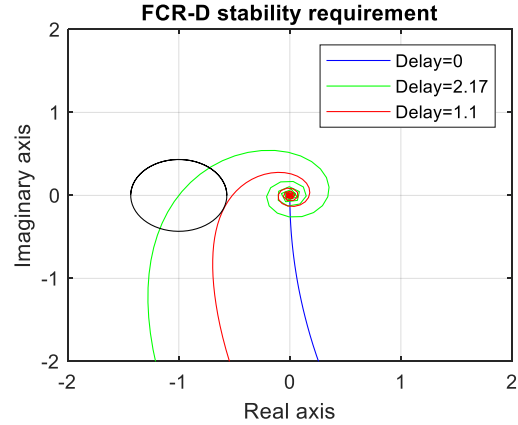

Figure 10. The blue curve shows the Nyquist curve of the FCR-D system without delay, the green curve shows the system with delay corresponding to the delay margin, and the red curve shows the system with the maximal delay that fulfills the stability margin.

If the unit or group that should provide FCR-N has a total time delay for frequency measurement, controller and actuation of the full required power change less than 0.67 seconds, a purely proportional controller can thus be used. For FCR-D, the total time delay needs to be less than 1.1 seconds. For many technologies, this is difficult to achieve. For example, the power might respond gradually rather than immediately to a change in the control signal. Such behavior has different impact on the Bode and Nyquist curves than a pure delay has. In the following section, PI-controllers with droop and systems with gradual response will be discussed.

2.2 Typical case – PI controller with droop

We will now study the system in Figure 1, where the controller is a PI controller with droop on independent form according to Eq. 1-3 with $E_p = 0.04$, $K_p = 2$ and $T_{feedback} = 60$, and the unit is a hydropower unit according to Eq.1-4 with $T_w = 1.5$.

The frequency response of the *open loop system* (without the negative feedback signal which is drawn with dashed line) is plotted in Figure 11. The blue line shows the frequency response of $G_{sys}(s)$ only. The red line shows the hydropower unit in series with the system. The hydropower units adds 180° negative phase shift and makes the system unstable (the red dot in the magnitude plot shows that the gain at -180° phase shift is larger than one, and the red dot in the phase plot shows that the negative phase shift at magnitude 1 is larger than 180°). To avoid the instability, the controller needs to either advance the phase or decrease the magnitude around the crossover frequency. The PI controller with droop decreases the magnitude but also increases the negative phase shift at mid-range frequencies, as can be seen by the green and magenta lines in the plot. The system with PI controller with droop, hydropower unit and grid (magenta line) is stable since the magnitude is pushed below 1 in the frequency range where the negative phase shift is larger than 180° .

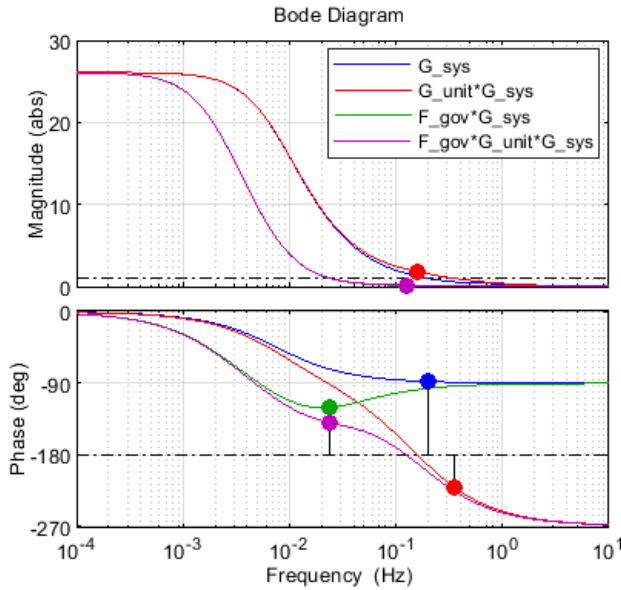

Figure 11. Open loop system with purely proportional control (blue), with purely proportional control of a hydropower unit (red), with PI with droop control without the hydropower unit (green) and with PI with droop controller on a hydropower unit (magenta).

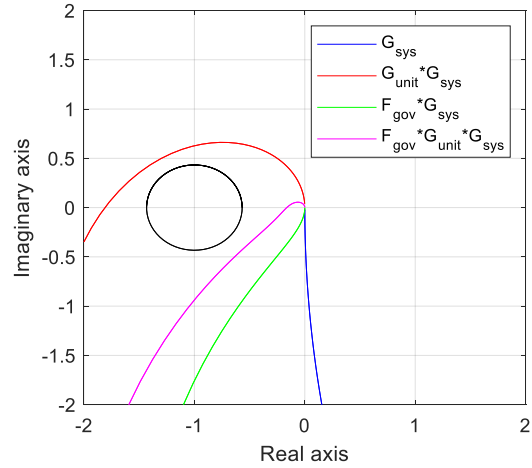

Figure 12. Nyquist diagram of the same systems as in Figure 11.

The PI controller with droop can thus solve the stability problem at higher frequencies caused by the non-minimum phase zero of the hydropower unit. However, the increased phase shift at mid-range frequencies can cause a new problem, if it becomes large enough. This can be seen in Figure 13, where the proportional part of the controller, K_p , is varied. When K_p is small (blue line), the phase curve approaches -180° at frequency 0.022 Hz (45 second period). Increasing K_p to 2 decreases the negative phase shift and increases the stability margin. This can also be seen in Figure 14, where the blue line crosses into the circle while the red line passes below. Further increase of K_p (green line) decrease the negative phase shift even more for frequencies around 0.022 Hz, but instead decrease the margin at higher frequencies. Increasing K_p even more (magenta line) takes the Nyquist curve inside the circle, now at frequencies around 0.11 Hz (9 second period).

To conclude, the proportional gain must be limited in order to avoid stability problems at higher frequencies, but it must be high enough to not cause a new stability problem at mid-range frequencies.

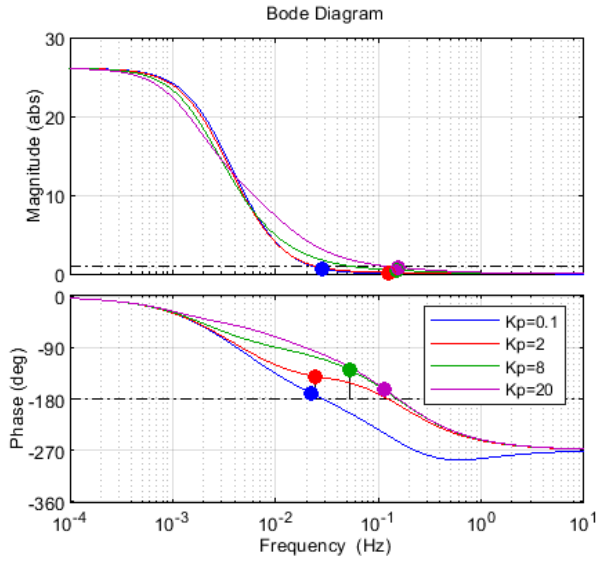

Figure 13. Bode diagram of the open loop system $F(s)G_{unit}(s)G_{sys}(s)$ with varying parameter K_p .

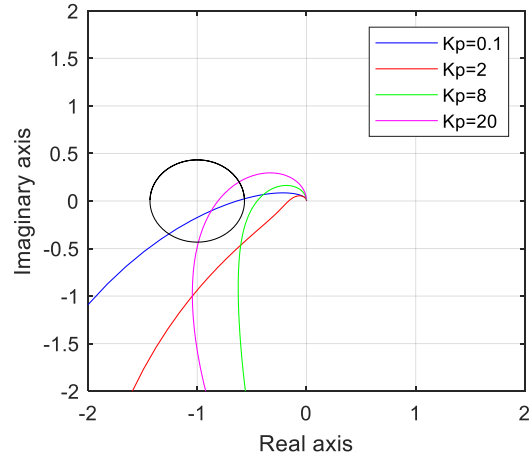

Figure 14. Nyquist curves for the same systems as plotted in Figure 13.

Figure 15 and Figure 16 shows how the stability is affected by changing the feedback time constant, $T_{feedback}$ (through changing the integral gain, K_i). A shorter feedback time constant can move the Nyquist curve to the left and cause stability problems. To compensate, the proportional gain can be increased. Figure 17 and Figure 18 shows the same system with $K_p = 8$. In this case, a higher proportional gain enables a faster integration by decreasing the negative phase shift in the mid-range.

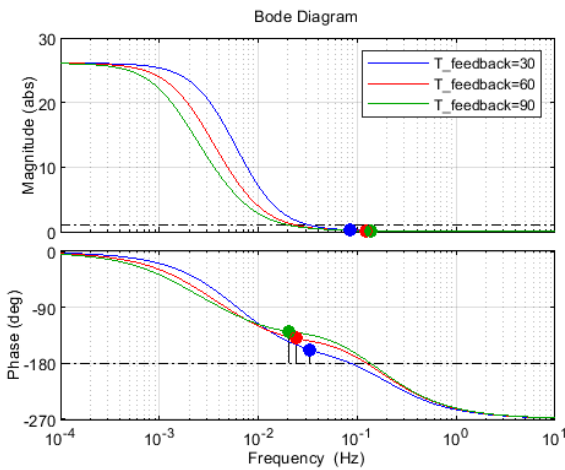

Figure 15. Bode diagram of the open loop system $F(s)G_{unit}(s)G_{sys}(s)$ with varying feedback time constant. Here, $K_p=2$.

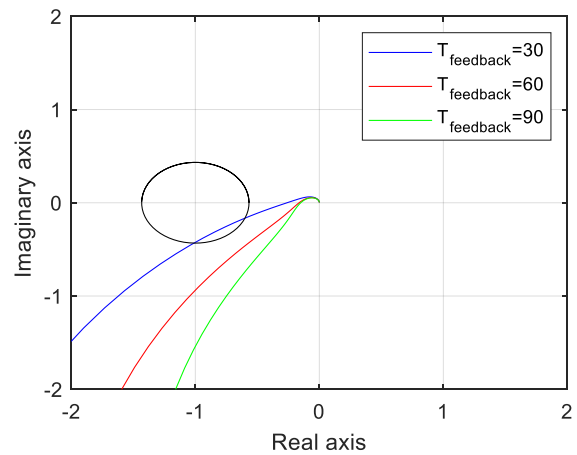

Figure 16. Nyquist curves for the same systems as plotted in Figure 15..

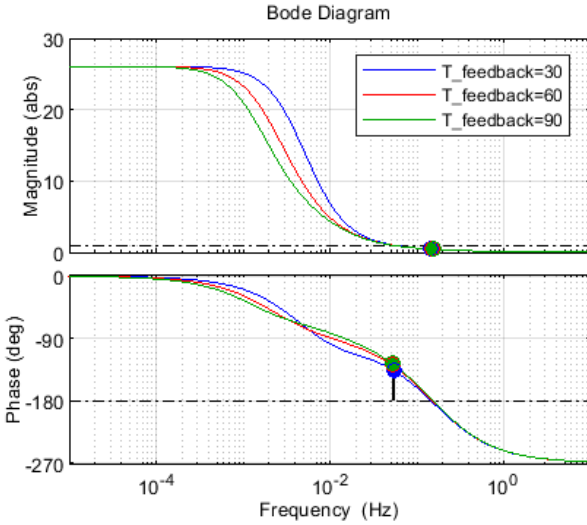

Figure 17. Bode diagram of the open loop system $F(s)G_{unit}(s)G_{sys}(s)$ with varying feedback time constant. Here, $K_p=8$.

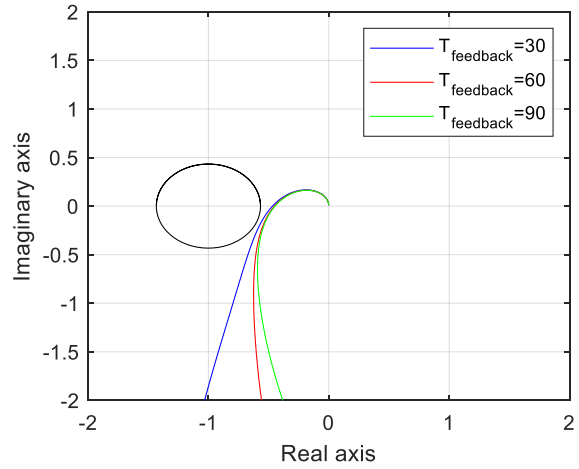

Figure 18. Nyquist curves for the same systems as plotted in Figure 17.

3 Performance

In addition to having a sufficient stability margin, the FCR is also required to be effective in disturbance attenuation. To analyze the performance of the FCR, we close the loop of the system in Figure 1 and look at the impact of disturbances, $P_{disturbance}(s)$. The disturbance attenuation requirement curve (performance requirement) is drawn by a black line in Figure 19 and a black dashed line shows the 95% margin allowed on the requirement. The figure shows the same controller and unit model with the same parameters and varying K_p as in the stability analysis in Figure 13 and Figure 14 but the system model has different parameters. The blue curve with low proportional gain has a high peak that makes the curve go above the requirement curve (i.e. the frequency deviations for normal disturbances would go above 0.1 Hz if all of FCR was controlled like this). The red line with $K_p = 2$, which passed the stability requirement, exceeds the requirement curve slightly (see zoom in Figure 20), but passes the requirement since the curve is below the dashed black curve showing the allowed margin of 95%. If K_p is increased to 8 (green line), the performance requirement is passed with good margin.

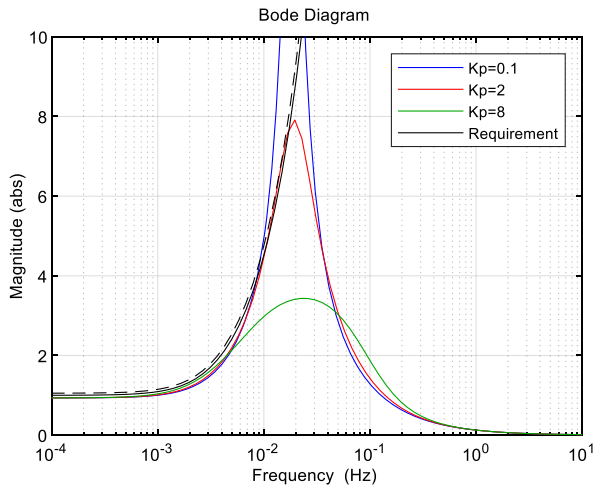

Figure 19. Closed loop system with varying K_p should stay below the black performance requirement line to fulfill the requirement.

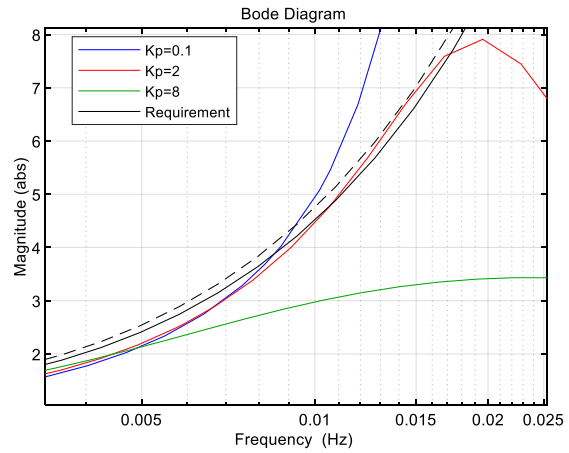

Figure 20. Zoom on the left flank of the peaks in Figure 19.

The feedback time constant also have an impact on the performance. Figure 21 shows the closed loop system where the feedback time constant is varied. A shorter feedback time constant pushes low frequency flank of the peak towards higher frequencies. Since the disturbance profile has a time constant of 70 seconds, it is not feasible with a feedback time constant longer than 70 seconds in the controller.

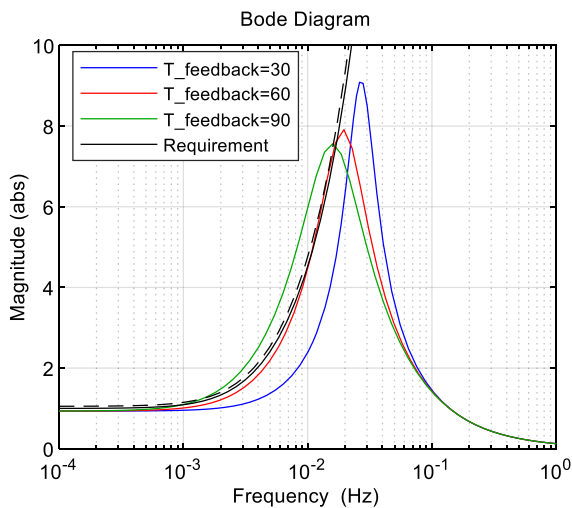

Figure 21. Closed loop system with varying feedback time constant compared to the performance requirement. Here, $K_p=2$.

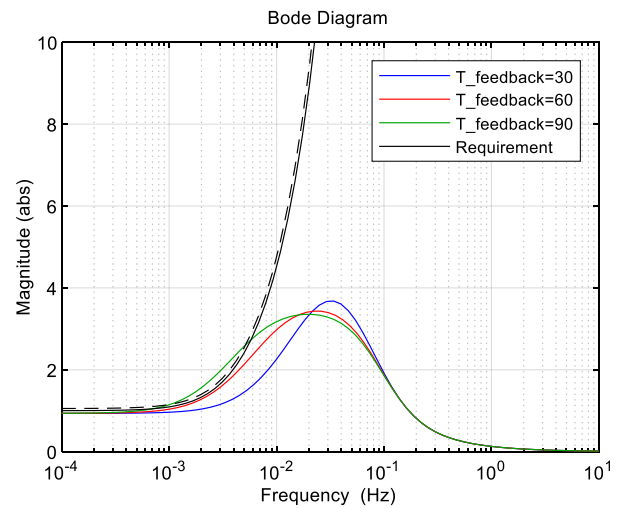

Figure 22. Closed loop system with varying feedback time constant compared to the performance requirement. Here, $K_p=8$.

It can also be noted from Figure 21 that decreasing the feedback time constant while keeping the proportional gain constant can lead to a higher peak. In this case, the peak can be reduced for all feedback time constants by increasing K_p , as can be seen in Figure 22. Although the peak is decreased, the performance requirement is not fulfilled with feedback time constant 90 seconds, since the controller does not give enough disturbance attenuation at lower frequencies.

4 Droop

In a linear model such as the one discussed in the previous sections, the droop E_p will not affect the stability or performance of the unit if the other parameters are scaled linearly with the gain or regulating strength of the controller. For the independent form PI controller with droop, linear scaling means that the proportional gain should be a constant factor of the steady state gain, i.e. $K_p = \frac{K}{E_p}$ where K is the same for all droops, and the feedback time constant should be kept constant, i.e. $K_i = \frac{1}{T_{feedback}E_p}$.

Figure 23 shows the Bode diagram of the controller F_{gov} where the droop E_p is varied while the parameters K_p and K_i are fixed. Figure 25 shows the same, but with the static gain scaled to one. With fixed parameters, the behavior is “slower” for low droop and “faster” for high droop.

Figure 24 shows the same controller but where the parameters K_p and K_i are scaled with the inverse of the droop. Figure 26 shows the same but with the static gain scaled to one. With scaled parameters, the phase curve is the same independent of the droop, and the magnitude curve of the scaled controller is identical for all droops.

It should be noted that with linear scaling of the proportional gain, it will increase with the regulating strength. Since high proportional gain can lead to bad damping of local oscillation modes, it may be necessary to limit the maximum regulating strength (minimum droop) to avoid high proportional gain.

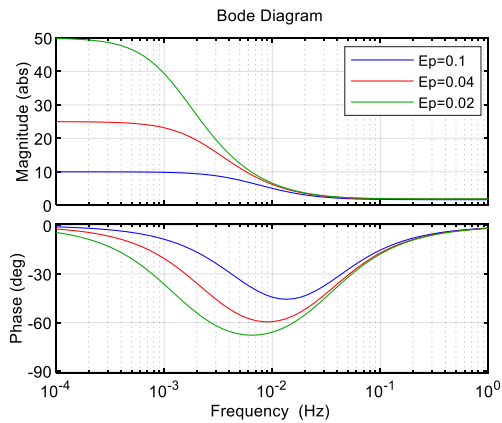

Figure 23. Varying droop with fixed parameters $K_p=2$, $K_i=0.4167$.

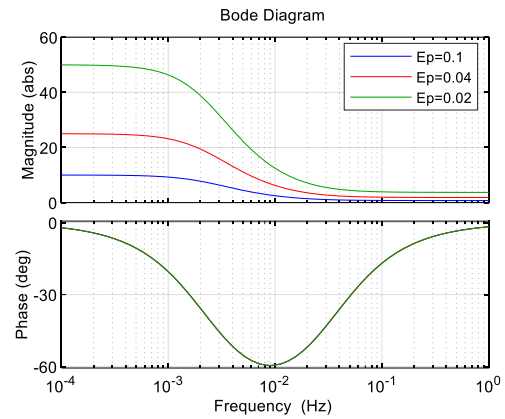

Figure 24. Varying droop with linear parameter scaling, $K_p=0.08/E_p$, $K_i=1/(60 \cdot E_p)$.

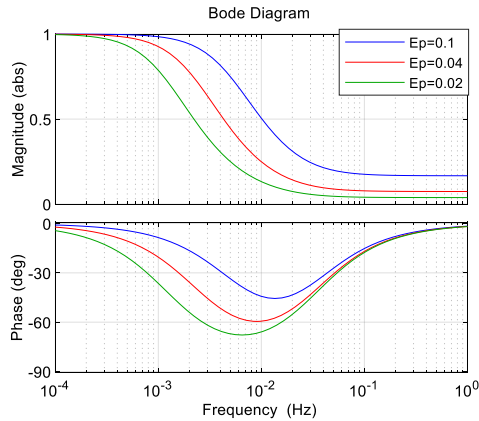

Figure 25. Varying droop with fixed parameter, same as Figure 23, scaled to have static gain = 1.

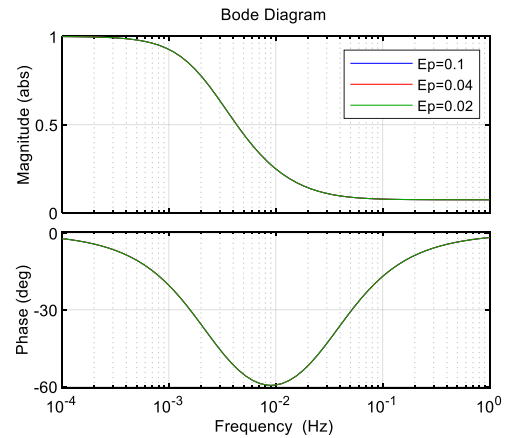

Figure 26. Varying droop with linear parameter scaling, same as Figure 24, scaled to have static gain = 1.

Even with linear scaling of the controller, there are in practice often non-linearities that affect the unit behavior more on high or on low droop and might limit the range of droop that can fulfill the technical requirements. The RfG (the Network Code on Requirements for Generators) requires that the droop settings for power generating modules shall be between 2% and 12% (Article 13.2.d), i.e. a regulating strength from 16.7%/Hz to 100%/Hz. Both the high and the low end of this range might be challenging for some existing units. The typical problems are described in the two next sections.

4.1 Typical problems at high droop

At high droop (low regulating strength), the regulation at typical frequency deviations is small. This means that backlash phenomena caused by for example valves, mechanical connections, friction or material elasticity might have a significant impact on the dynamic performance.

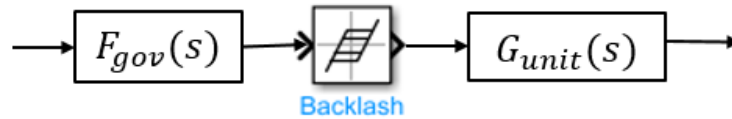

Figure 27. Block diagram of a unit with backlash.

Figure 27 shows a block diagram of a unit with backlash, where the backlash is assumed to be located in the actuator equipment after the controller. Figure 28 shows how the size of the backlash impacts the Bode diagram of the unit including controller and backlash. The backlash decreases the amplitude and increases the negative phase shift, especially at higher frequencies. The reason why the backlash has more impact on higher frequencies is because of the low-pass characteristics of the governor. The amplitude of the input signal to the backlash is smaller on higher frequencies, and therefore the impact is greater. In itself, the dynamics of the backlash is not frequency dependent but amplitude dependent.

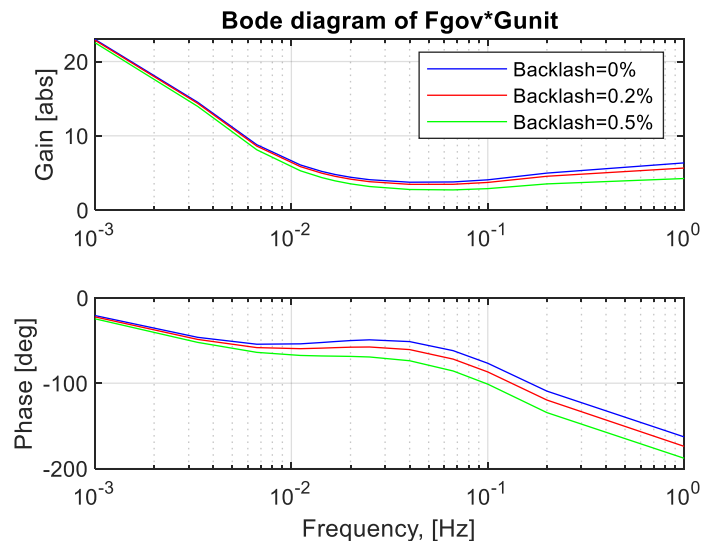

Figure 28. Bode diagram of a unit with backlash as depicted in Figure 27. Here, the controller is an independent for PI controller with droop with $E_p=0.04$, $K=0.15$, $T_{feedback}=60$ and varying backlash width.

Since the droop impacts the size of the input signal, a backlash of a given size will have more impact at high droop. This can be seen in Figure 29 and Figure 30 which shows how the Nyquist curve and the closed loop performance curve change with the droop because of backlash. Here, the controller parameters are linearly scaled with the droop so the differences in the curves are entirely due to the 0.2% backlash included in the unit model. Backlash decreases the stability margin and worsen the performance of the unit. Increasing the proportional gain can counteract

the impact from backlash, as can be seen in Figure 31 and Figure 32 where the proportional gain is increased from $0.15/E_p$ to $0.2/E_p$.

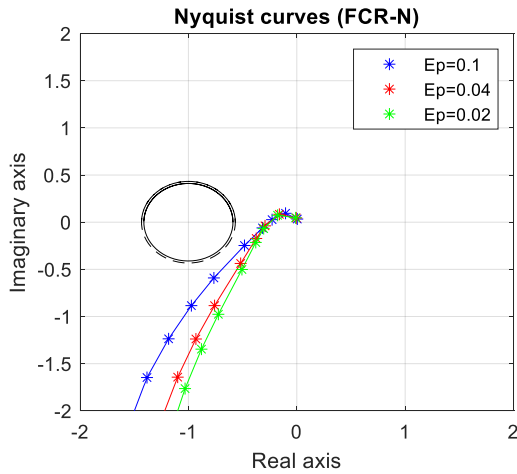

Figure 29. Nyquist curves for the open loop FCR-N system with varying droop and $K=0.15$, $T_{feedback}=60$ and backlash width 0.2%.

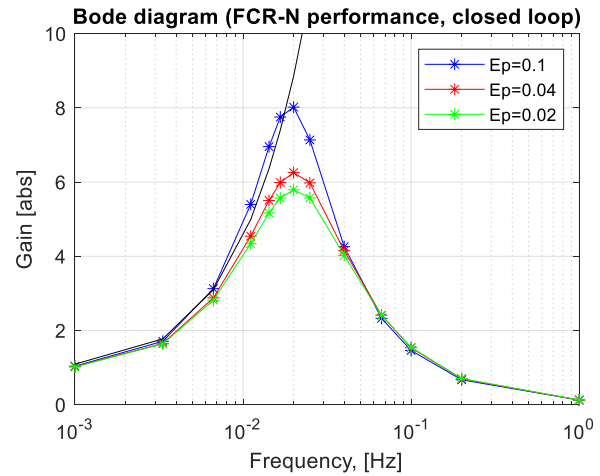

Figure 30. Amplitude curves of the closed loop FCR-N system with varying droop and $K=0.15$, $T_{feedback}=60$ and backlash width 0.2%.

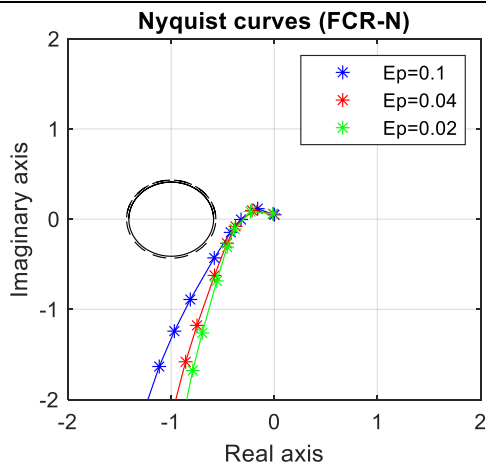

Figure 31. Same as Figure 29 but with $K=0.2$.

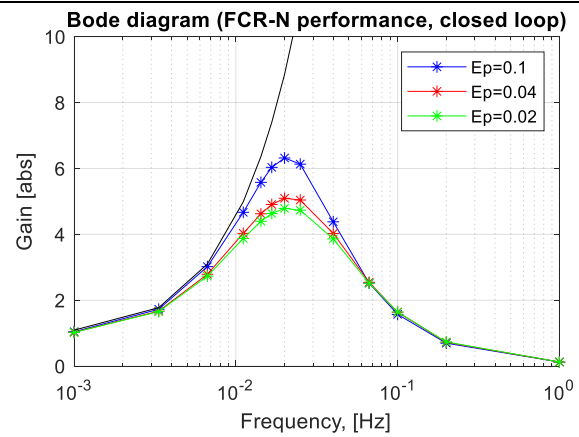

Figure 32. Same as Figure 30 but with $K=0.2$.

4.2 Typical problems at low droop

At low droop (high regulating strength), the regulation at typical frequency deviations is large. This means that rate limitations that might be implemented in the controller or be caused by limited regulating speed in valves or similar can impact the dynamic performance.

Figure 33 shows a block diagram of a unit with rate limitation, where the rate limit is assumed to be located in the actuator equipment after the controller. Figure 34 shows how rate limitations impacts the Bode diagram of the unit including controller rate limit. The rate limit decreases the amplitude and increases the negative phase shift, especially at higher frequencies. The reason

why the rate limit has more impact on higher frequencies is because the input signal changes faster and requires a faster regulation. As long as the required regulation is slower than the rate limitation, the rate limiter has no impact on the behavior. When the required regulation is faster than allowed by the rate limitation, the performance is deteriorated.



Figure 33. Block diagram of a unit with rate limit.

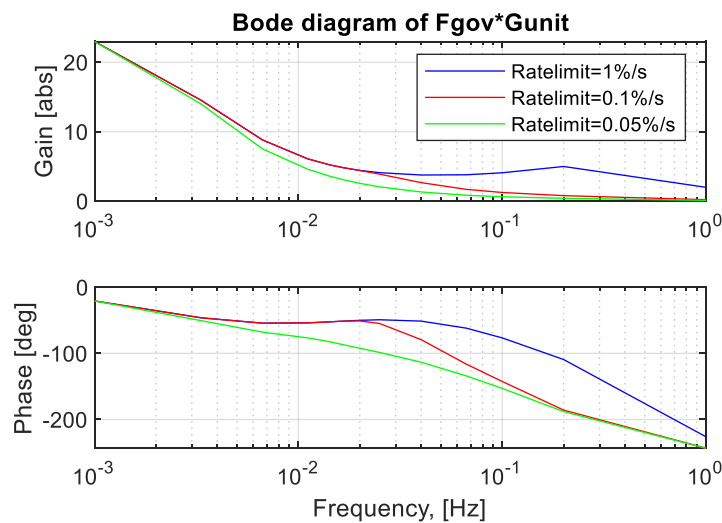

Figure 34. Bode diagram of a unit with rate limit as depicted in Figure 33. Here, the controller is an independent for PI controller with droop with $E_p=0.04$, $K=0.15$, $T_{feedback}=60$ and varying rate limit.

Since the droop impacts the speed of the input signal, rate limitations will have more impact at low droop. This can be seen in Figure 35 and Figure 36 which shows how the Nyquist curve and the closed loop performance curve change with the droop because of a given rate limit. Here, the controller parameters are linearly scaled with the droop so the differences in the curves are entirely due to the 0.1%/s rate limit included in the unit model. This rate limit has little impact at $E_p = 0.1$ (static gain 20%/Hz) and $E_p = 0.04$ (static gain 50%/Hz) but causes the unit to fail both the stability and performance requirements at $E_p = 0.02$ (static gain 100%/Hz).

It is typically not possible to address the failure to fulfill the stability and performance requirement due to rate limitations by changing parameters in the PI-controller. Instead, the maximal capacity (minimum droop) will be limited.

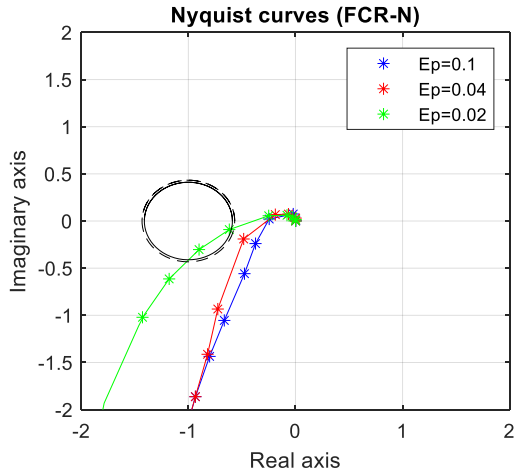

Figure 35. Nyquist curves for the open loop FCR-N system with varying droop and $K=0.15$, $T_{feedback}=60$ and rate limit $0.1\%/s$.

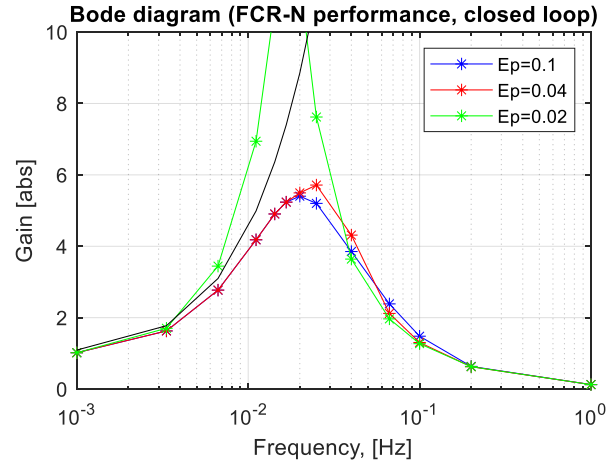

Figure 36. Amplitude curves of the closed loop FCR-N system with varying droop and $K=0.15$, $T_{feedback}=60$ and rate limit 0.1% .

Low droop can also lead to linearity problems if the relation between the power output and the controlled signal is non-linear. Larger regulations then typically lead to more deviation from the expected MW/Hz static gain. This is further discussed in the next section.

5 Feedback signal

Although many units use some type of PI or lead-lag controller, the implementation varies. One important difference between controller implementations is which signal or signals that are used for feedback.

Figure 37 shows a controller setup where the guide vane opening or guide vane servo position, Y [%], is used as feedback signal both for changes in production setpoint and for frequency control. With this setup, the guide vane setpoint, $Y_{setpoint}$, is typically determined in a higher level system, using known relations between guide vane opening, power and head. The FCR capacity in MW and/or the regulating strength in MW/Hz also needs to be calculated from the head and the guide vane setpoint, since the parameter E_p [Hz/% or pu/pu] is related to guide vane opening and not to power.

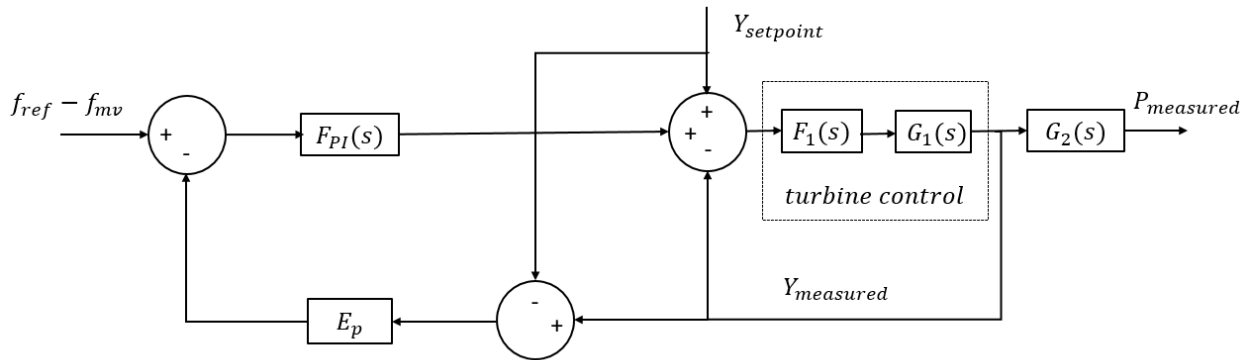

Figure 37. Block diagram of a control setup with guide vane feedback.

Figure 38 shows another controller setup where the feedback to the frequency control is internal in the controller, i.e. its contribution to the guide vane setpoint is used as feedback instead of its contribution to the guide vane measured value. The guide vane opening is controlled with a separate feedback loop, the same as in Figure 37. One advantage of this setup is that gain scheduling to linearize the frequency control can be added in a simpler way than with the setup in Figure 37. The frequency control loop can operate in MW/Hz instead of %/Hz, and the output from the frequency control can be translated from a power change to a guide vane change, using the head and the known relations between guide vane opening, head and power. The droop parameter E_p can then be set in Hz/MW instead of Hz/%.

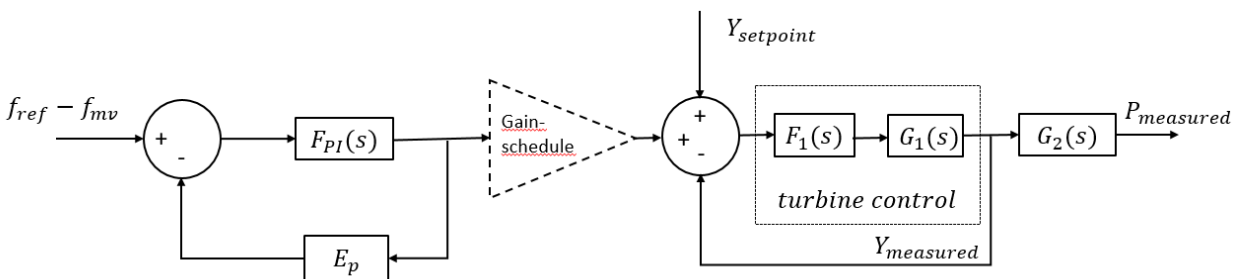

Figure 38. Block diagram of a control setup with internal feedback in the controller and guide vane feedback in a separate loop.

Another possible control setup is to use power as feedback signal. However, power feedback is not recommended for synchronous generators that are synchronously connected to the grid, since it will counteract the stabilizing contribution of rotational energy and damping from the generator to the power system¹. Providers might wish to implement power feedback to get a direct control of the power output from the unit, but it is preferable to use some type of gain scheduling, possibly in combination with very slow power feedback. Power feedback that is fast enough to counteract the response from the rotational energy of the unit should not be used.

¹ See also "Effekt- och pådragsåterkoppling för en synkron kraftproduktionsmodul" by Lena Max och Evert Agneholm (Svk, 2022). The document is not yet publically available.

6 A model-based approach to controller tuning

One way to find a suitable tuning of the FCR controller is to set up a model of the controller and the unit and make a preliminary tuning on the model. This is one recommended approach. However, sometimes the available models are too simplified, or the model parameters are difficult to determine. Preliminary sine tests can then be used to estimate a Bode diagram of the unit's behavior in frequency control, which can be used for tuning with regards to the frequency domain requirements. A method for such tuning will be described in this section.

What is needed?

- The transfer function of the controller (derived for example from the block diagram of the controller).
- Sine tests for one operating point and droop, preferably high load and high droop or the point where the requirements are expected to be most difficult to fulfil.

Method:

1. Calculate the response for each sine test for the controller and unit, $F(i\omega)$.
2. Calculate the governor frequency response for each sine, $F_{gov}(i\omega)$, from the transfer function, $F_{gov}(s)$, using the controller parameters that were used during the test.
3. Since $F(i\omega) = F_{gov}(i\omega)G_{unit}(i\omega)$, the unit frequency response can now be calculated as $G_{unit}(i\omega) = F(i\omega)(F_{gov}(i\omega))^{-1}$.
4. Calculate the governor frequency response for another set of governor parameters.
5. Calculate the frequency response with retuned governor, $F_{new}(i\omega) = F_{gov,new}(i\omega)G_{unit}(i\omega)$. A wide range of tunings can be tested.
6. Check the performance and stability criteria for the new frequency response, $F_{new}(i\omega)$.

The advantage of this tuning method is both that it is quite reliable for at least relatively small changes to the controller parameters (depending on how non-linear G_{unit} is) and that it is relatively simple. If the frequency response $F(i\omega)$ is calculated by the IT tool, the only calculations needed are algebra with complex numbers. The drawback is that the time domain requirements cannot be analyzed directly from the frequency response. Those requirements will set additional boundaries to the acceptable parameter settings.

7 Equipment

A prerequisite for fulfillment of the technical requirements for FCR is that the power output from the entity can be controlled swiftly and accurately. Fast and accurate measurement of frequency and power are also necessary. Modern transducers are digital devices where averaging of the signal can be set in the range of 40 ms to more than 1 s. While it is beneficial to have some averaging or filtering to suppress measurement noise, a long frequency transducer response time increases the phase shift of the control system and can have a negative impact on performance and

stability. Long response time of the frequency and/or power transducer can also spoil the test results and deteriorate the quality of logged data during normal operation.

Recommendations for frequency and power transducers:

- The maximum time constant of the transducer should be 100 ms.
- The maximum averaging should be 5 periods or 100 ms.

8 Appendix

8.1 Explanation of the performance requirement

In addition to having a sufficient stability margin, the FCR is also required to be effective in disturbance attenuation. The disturbance profile (variations in production and load) can be approximated as white noise (amplitude =1) passed through a filter $D_1(s) = \frac{600 \text{ MW}/S_n}{70s+1}$. The frequency variations from such disturbances should not exceed 0.1 Hz.

Figure 39 shows the block diagram of the system. The FCR branch is first scaled by the steady state gain of $F_{gov}G_{unit}$, $K_{scaling}$ in the figure, and then by the total volume of FCR in the system. The disturbance in per unit enters after this scaling. The block diagram in Figure 39 can be redrawn as in Figure 40, where the scaling factor for the system FCR volume is moved to after the summation point, and consequently the inverse of this scaling factor ends up in the disturbance branch. Now the summation is outside the block $G(s)$.

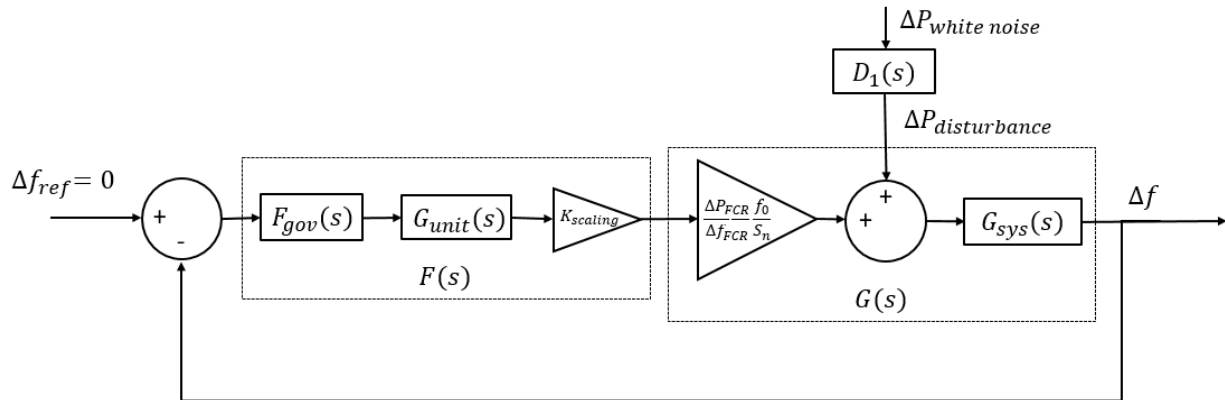

Figure 39. Block diagram of the system with disturbance.

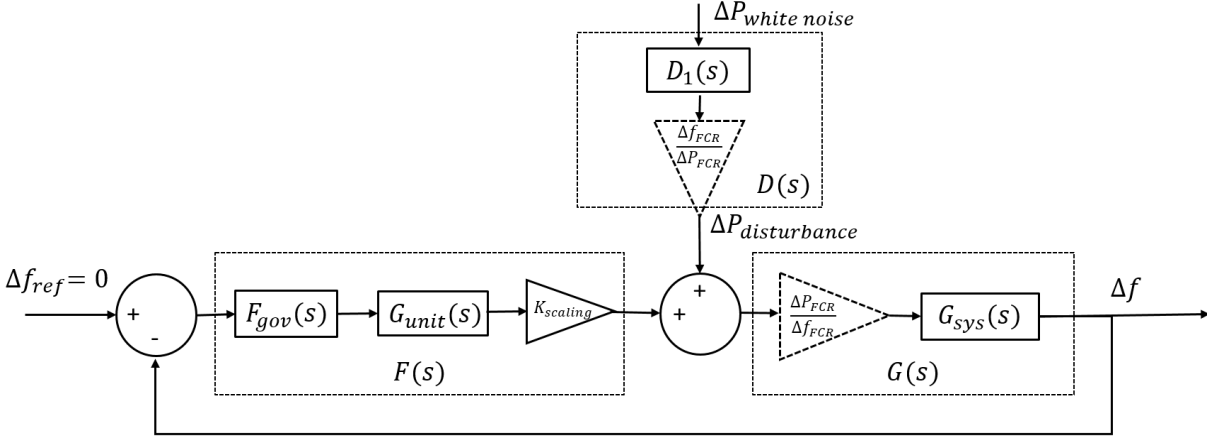

Figure 40. Block diagram equivalent to Figure 39, where the scaling factor for system FCR volume is moved so that the summation is outside $G(s)$.

The frequency deviation can be expressed as

$$\Delta f = \frac{G(s)}{1+F(s)G(s)} \Delta P_{disturbance} = \frac{G(s)}{1+F(s)G(s)} \frac{0.1/f_{base}}{600/P_{base}} \frac{600/P_{base}}{70s+1} \Delta P_{white\ noise}. \quad 8.1$$

Rearranging the equation gives

$$\frac{\Delta f}{\Delta P_{white\ noise}} \frac{70s+1}{0.1/f_{base}} = \frac{G(s)}{1+F(s)G(s)}. \quad 8.2$$

The performance requirement is that typical disturbances $P_{disturbance}$ should not cause frequency deviations larger than 0.1 Hz. Inserting the magnitude of this frequency deviation in per unit, $\Delta f = 0.1/f_{base}$, and acknowledging that $|\Delta P_{white\ noise}| = 1$, the requirement on the closed loop system can be expressed as

$$\left| \left(\frac{1}{70s+1} \right)^{-1} \right| > \left| \frac{G(s)}{1+F(s)G(s)} \right|, \quad 8.3$$

which is the requirement given in the Technical requirements document.