Supporting Document on Technical Requirements for Frequency Containment Reserve Provision in the Nordic Synchronous Area

29 March 2021

Version for the pilot phase

Contents

Definitions	4
1 Introduction	5
2 The prequalification process	6
3 Test procedure	7
3.1 FCR-N	9
3.1.1 FCR-N step tests	9
3.1.2 FCR-N sine tests	9
3.2 FCR-D	10
3.2.1 FCR-D upwards stationary performance test	10
3.2.2 FCR-D upwards ramp response test	11
3.2.3 FCR-D downwards stationary performance test	12
3.2.4 FCR-D downwards ramp response tests	12
3.2.5 FCR-D sine tests	13
3.3 Special considerations	14
3.3.1 Separate test of frequency measurement loop	14
3.3.2 Linearity test	15
3.3.3 FCR-D with separate high performance and high stability parameters	15
3.3.4 Deactivation	16
4 Evaluation of compliance	17
4.1 Deriving FCR-N and FCR-D transfer function values from testing	17
4.1.1 Base values	17
4.1.2 Gain and phase shift	20
4.1.3 Frequency measurement loop	24
4.2 Evaluation of FCR-N requirements	25
4.2.1 Evaluation of FCR-N requirement for stationary activation	25
4.2.2 Evaluation of FCR-N requirement for dynamic performance	25
4.2.3 Evaluation of FCR-N requirement for dynamic stability	27
4.3 Evaluation of FCR-D requirements	29
4.3.1 Evaluation of FCR-D requirements for stationary activation	29
4.3.2 Evaluation of FCR-D requirements for dynamic performance	31
4.3.3 Evaluation of FCR-D requirements for dynamic performance for deactivation	32
4.3.4 Evaluation of FCR-D requirements for dynamic stability	32
4.4 Evaluation of requirement of switch over between FCR-N and FCR-D	34
4.5 Evaluation of linearity requirement	34
4.6 Capacity determination for operational points within the tested interval	36
4.7 Capacity determination for uncertain or varying responses	40

5	FCR capacity calculation for real-time telemetry and data logging	40
5.1	Maintained FCR-N capacity	41
5.2	Maintained FCR-D capacity	41
5.3	FCR providing entities with limited energy reservoir (LER)	42
5.4	Activated FCR capacity calculation.....	44
6	Appendices	45
	Appendix 1: Determination of operational conditions to perform tests	45
	Appendix 2: Different graphical representations of FCR dynamic requirements	50

Definitions

Activated capacity	Part of the active power output caused by FCR activation
aFRR	Automatic Frequency Restoration Reserve
Backlash	General denotation of mechanical deadband / insensitivities / backlash
Connection Point	The interface at which the providing entity is connected to a transmission system, or distribution system, as identified in the connection agreement
Droop	The ratio of a steady-state change of frequency to the resulting steady-state change in active power output, expressed in percentage terms. The change in frequency is expressed as a ratio to nominal frequency and the change in active power expressed as a ratio to maximum capacity or actual active power at the moment the relevant threshold is reached.
ENTSO-E	European Network of Transmission System Operators for Electricity
FCP	Frequency Containment Process
FCR	Frequency Containment Reserve
FCR-D	Frequency Containment Reserve for Disturbances
FCR-N	Frequency Containment Reserve for Normal operation
FCR provider	Legal entity providing FCR services from at least one FCR providing unit or group
Controller parameter set	A set of preselected parameter values, selectable with a single signal, e.g. a certain parameter set for island operation and another one for FCR-N
Maintained capacity	The amount of reserve in MW that will be utilized at full activation, FCR-N 50 ± 0.1 Hz, FCR-D at 49.5 Hz for upwards regulation and 50.5 Hz for downwards regulation
Power system stabiliser	An additional functionality of the Automatic Voltage Regulator of a synchronous power-generating module whose purpose is to damp power oscillations
Prequalification	Prequalification means the process to verify the compliance of an FCR providing unit or an FCR providing group with the requirements set by the <i>Technical Requirements for Frequency Containment Reserve Provision in the Nordic Synchronous Area</i>
Providing entity	FCR Providing Unit or FCR Providing Group
Providing group	FCR Providing Group means an aggregation of Power Generating Modules, Demand Units and/or Reserve Providing Units and/or Energy storages connected to more than one Connection Point fulfilling the requirements for FCR
Providing unit	FCR Providing Unit means a single or an aggregation of Power Generating Modules and/or Demand Units and/or Energy storages connected to a common Connection Point fulfilling the requirements for FCR
TSO	Transmission System Operator
Setpoint	Part of the active power output that does not include FCR activation

1 Introduction

This document supports the Main document, *Technical Requirements for Frequency Containment Reserve Provision in the Nordic Synchronous Area*, aiming towards a common Nordic harmonization of the technical requirements for frequency containment reserves (FCR) within the Nordic power system.

The objective of the frequency containment reserves is to stabilise and maintain the frequency in case of imbalances. FCR is a fast power activation that activates automatically and proportionally in response to a deviation in frequency within certain intervals. FCR for normal operation (FCR-N) stabilises fluctuations between production and consumption in normal operation and FCR for disturbances (FCR-D) stabilises large power imbalances that may occur.

In this document concepts and terminologies used in the Main document and throughout this document are explained. In section 2 the process for prequalification is presented. The test procedure is presented in section 3. The application of the test results in evaluating requirements compliance, including derivation of the mathematical representations of the dynamic behaviour of FCR providing entities, is explained in Section 4 to provide a better understanding on how an entity's dynamic behaviour is evaluated. FCR capacity calculation for real-time telemetry and data logging purposes is explained in Section 5.

2 The prequalification process

The prequalification process shall ensure that the FCR provider is capable of providing FCR in accordance with the requirements from the TSO. The prequalification process is harmonized between the Nordic TSOs, and it is based on the requirements given to the TSOs through the European guidelines from the European Commission¹. The process shall also ensure that the respective TSO has all the necessary documentation for the FCR providing entities. Furthermore, the process must ensure that the correct communication links are established and that the required telemetry is received. The required tests, documentation and data are further described in this document and stated in the Main document. The prequalification process is illustrated in Figure 1.

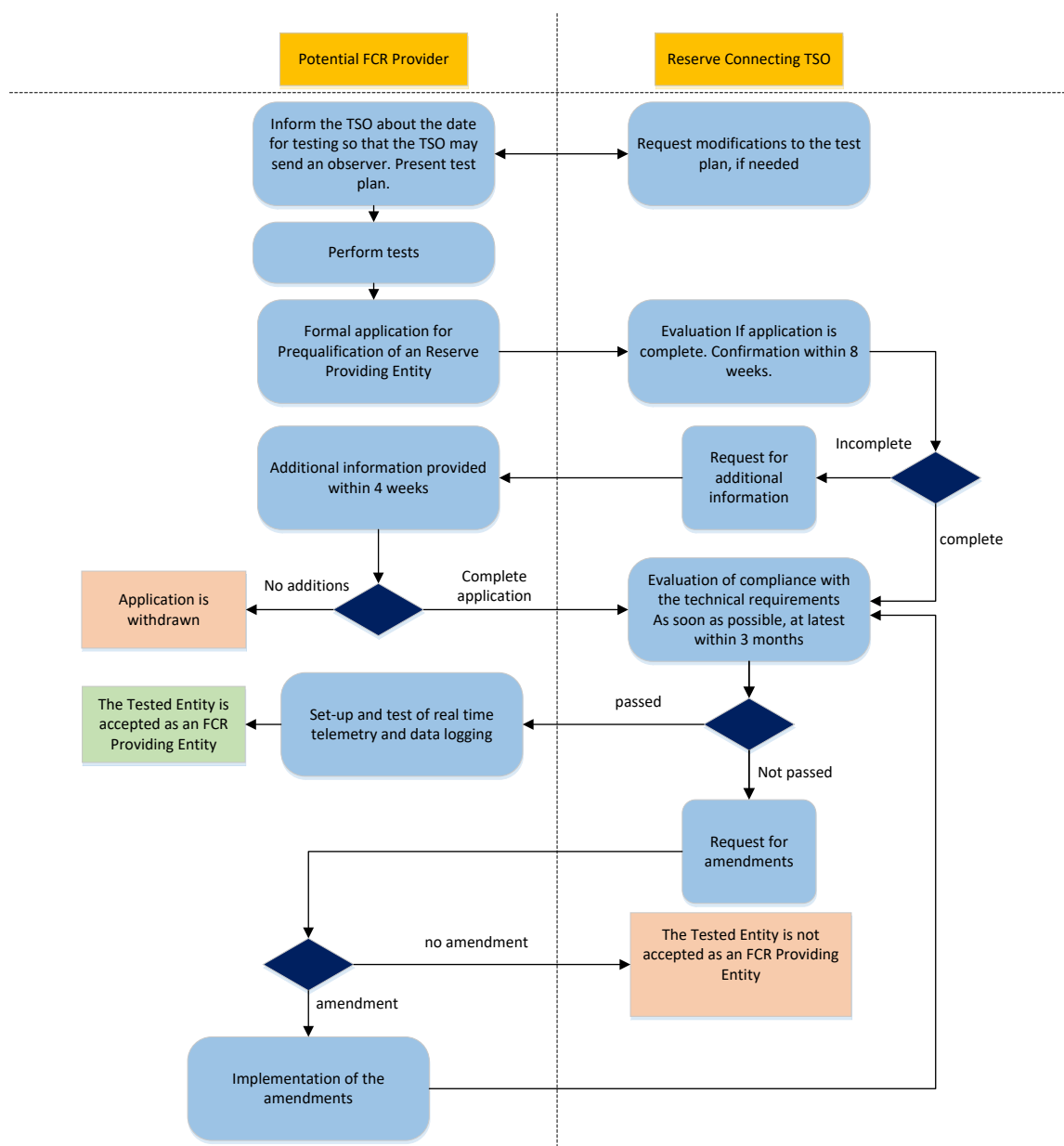

Figure 1. Illustration of the steps in the prequalification process.

¹ COMMISSION REGULATION (EU) 2017/1485 of 2 August 2017 establishing a guideline on electricity transmission system operation.

3 Test procedure

The FCR providing entity shall be synchronized to the grid during the test. The frequency control signal, normally from the measured grid frequency, is replaced by an applied test signal as illustrated in Figure 2.

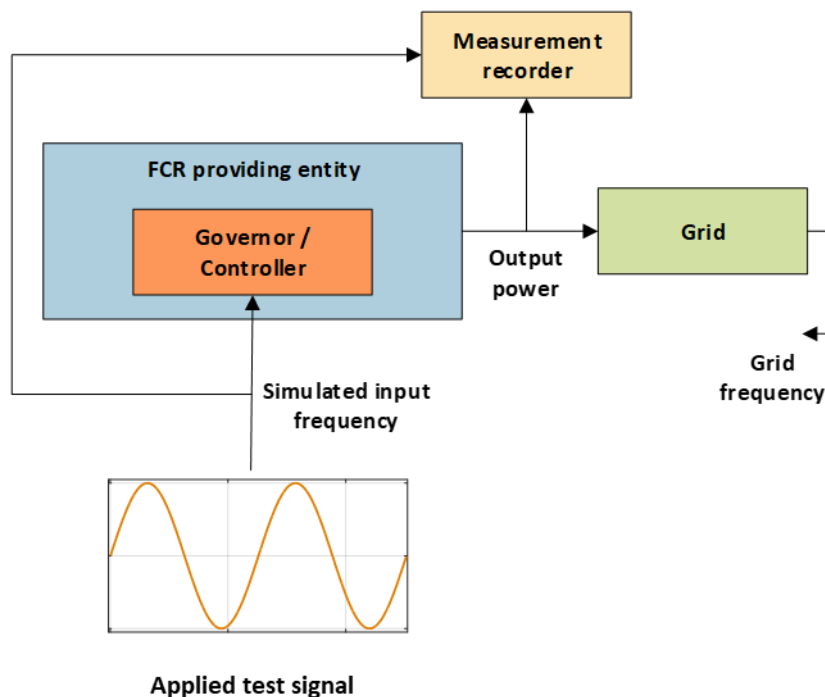

Figure 2. Principle test setup.

If the FCR providing entity being tested is equipped with a Power System Stabilizer (PSS) that interacts with FCR activation, the PSS shall be disabled while performing the tests. During testing, supplementary active power controls like aFRR shall be disabled so that the setpoint remains unchanged. Voltage control using frequency-voltage droop is allowed when it acts on the applied frequency signal.

A test set is designed to highlight the properties associated with FCR provision;

- Steady state activation (stationary performance)
- Dynamic performance
- Dynamic stability
- Linearity

A single test set contains, not including special considerations or possible exemptions;

- FCR-N
 - 1 step response sequence
 - 7 sine responses
- FCR-D upwards
 - 2 ramp response sequences
 - 5 sine responses

- FCR-D downwards
 - 2 ramp response sequences
 - 5 sine responses

Additional tests or considerations may be applicable depending on the FCR providing entities specific properties and test method. This includes

- Separate test for frequency measurement loop
- Linearity test for non-continuous responses, for FCR-N
- FCR-D with separate high performance and high stability parameters
- Deactivation

The FCR properties depend on both ambient and operational conditions, such as loading level (power setpoint), droop settings, water level height (hydro), temperature of cooling water (thermal), and many more. All ambient and operational conditions cannot be tested, so the requirements aim to highlight those most important.

The FCR providing entities must confirm compliance for the relevant operational ranges. Generally, it is required to complete one test set at a minimum of four operational conditions for FCR-N, FCR-D upwards, and FCR-D downwards:

- 1) *Maximum active power setpoint* where the entity will provide FCR, and *maximum droop*, and corresponding controller parameter sets, where the entity will provide FCR.
- 2) *Maximum active power setpoint* where the entity will provide FCR, and *minimum droop*, and corresponding controller parameter sets, where the entity will provide FCR.
- 3) *Minimum active power setpoint* where the entity will provide FCR, and *maximum droop*, and corresponding controller parameter sets, where the entity will provide FCR.
- 4) *Minimum active power setpoint* where the entity will provide FCR, and *minimum droop*, and corresponding controller parameter sets, where the entity will provide FCR.

If the above stated conditions are not applicable or representative for the FCR providing entity, the test conditions shall be agreed with the TSO prior to performing the tests. It is the responsibility of the FCR providing entity owner to clarify uncertainties with regard to necessary tests. For example, FCR providing entities, where the setpoint does not have any influence on the FCR response, can be tested at only one setpoint value. Similar exemptions can be given where relevant.

Exemptions given are listed below. Generally:

- If the entity is planned to deliver FCR at a single power setpoint, the tests 3) and 4) can be omitted.
- If the entity is planned to deliver FCR at a single droop setting, the tests 2) and 4) can be omitted.
- If a single parameter set is used for all power setpoints, sine testing at multiple power setpoints can be omitted. Maximum and minimum droop setting must be tested. The power setpoint where stability is most challenging, normally the highest, shall be tested. E.g. hydro power using a single parameter set for entire power setpoint range is required to perform stability testing for high loading only.
- Providers may choose to perform tests for only FCR-D upwards, only FCR-D downwards, or both.

Subject to TSO approval prior to testing:

- For technologies where power setpoint does not influence the FCR provision capabilities, testing at a single power setpoint is sufficient for both steady state, dynamic performance and dynamic stability. E.g. batteries.
- The reserve connecting TSO can give additional exemptions for testing requirements where compliance can be confirmed by the general knowledge of the technology, either from previous tests of similar units or other documentation. The potential FCR provider is responsible for clarifying this prior to testing.

Note also that the sine testing is similar for FCR-N, FCR-D upwards and FCR-D downwards. Results can where applicable be reused for confirming compliance for several products, assuming the same parameter set is used.

3.1 FCR-N

3.1.1 FCR-N step tests

A step response sequence is used to determine steady state FCR-N capacity, backlash, and performance. Synthetic step signals are injected in the frequency measurement loop, which gives a power response. The initial two steps, from 50.00 Hz to 50.05 Hz and back, are included to highlight the contribution of the backlash and similar non-linear effects. Each new step is injected after reaching steady state power response for a time sufficient enough to clearly confirm steady state activation.

50.00 Hz → 50.05 → 50.00 → 49.90 → 50.00 → 50.10 → 50.00 Hz

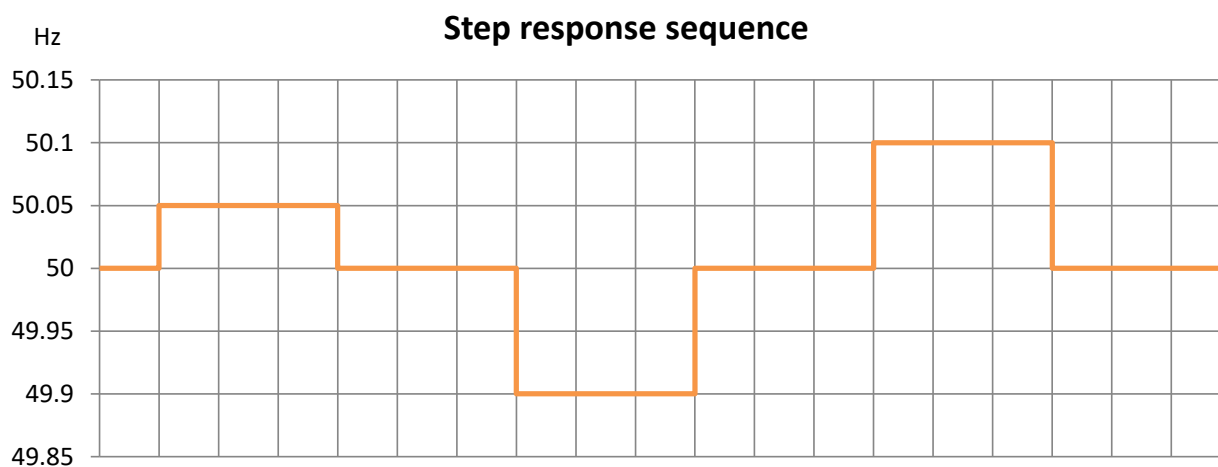

Figure 3. Input frequency signal for FCR-N step response tests

3.1.2 FCR-N sine tests

Sine tests are used to confirm stability and dynamic performance. Synthetic sinusoidal signals are injected in the frequency measurement loop, which gives a power response. For each time period, at least five periods shall be recorded after reaching a stable sinusoidal active power output.

The time periods for which to test is $T = [10, 15, 25, 40, 50, 60, 70]$ seconds. If the response already crosses the real axis ($\text{Im}=0$) in the Nyquist plane on the right side of the stability requirement circle for tested time periods, the testing of time periods less than or equal to 40 seconds can be omitted. The FCR provider may choose to perform tests at more time periods to investigate transfer function values in the area otherwise interpolated, see Subsection 4.1

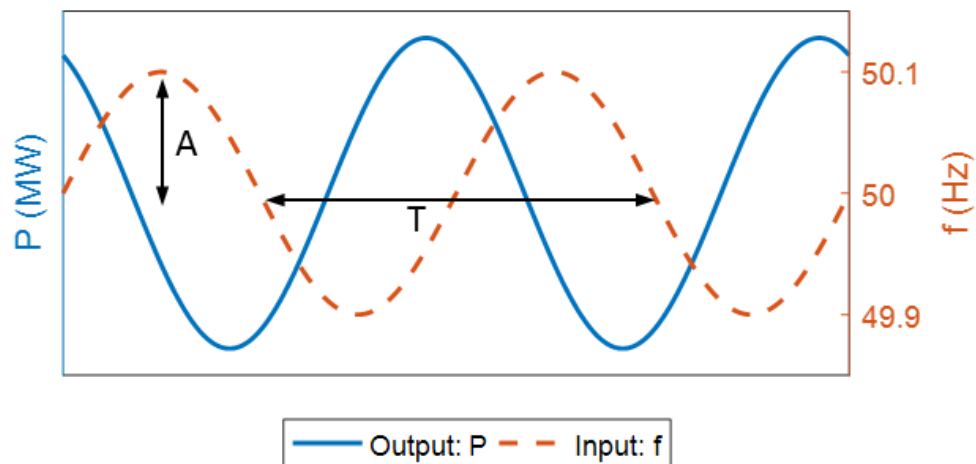

Figure 4. Input frequency signal for FCR-N sine tests

3.2 FCR-D

3.2.1 FCR-D upwards stationary performance test

A ramp response sequence is performed to determine steady state FCR-D upwards capacity and confirm linear activation of FCR-D. The ramps also provide necessary information about backlash and similar non-linear effects, and can be used for confirming correct switching of parameters between FCR-N and FCR-D.

For FCR providing entities with switching of parameter sets between FCR-N and FCR-D, the initial ramp from 50.00 Hz to 49.50 Hz is used for compliance evaluation, and in that case FCR-N needs to be active. This switchover is only necessary to test (i.e. to keep FCR-N active) at a single power setpoint, but for maximum and minimum droop settings. The ramp sequence remains the same even if switchover testing is not performed.

Both activation and deactivation shall be tested in the upwards direction. The ramp rate shall be at least 2 mHz/s, e.g. a full activation from 50 Hz to 49.5 Hz shall be made within maximum 250 seconds. A faster ramp rate may be chosen, up to 10 mHz/s, i.e. 50 seconds for full activation.

50.00 Hz → 49.50 → 49.70 → 49.90 → 49.70 → 49.50 → 49.70 → 49.90

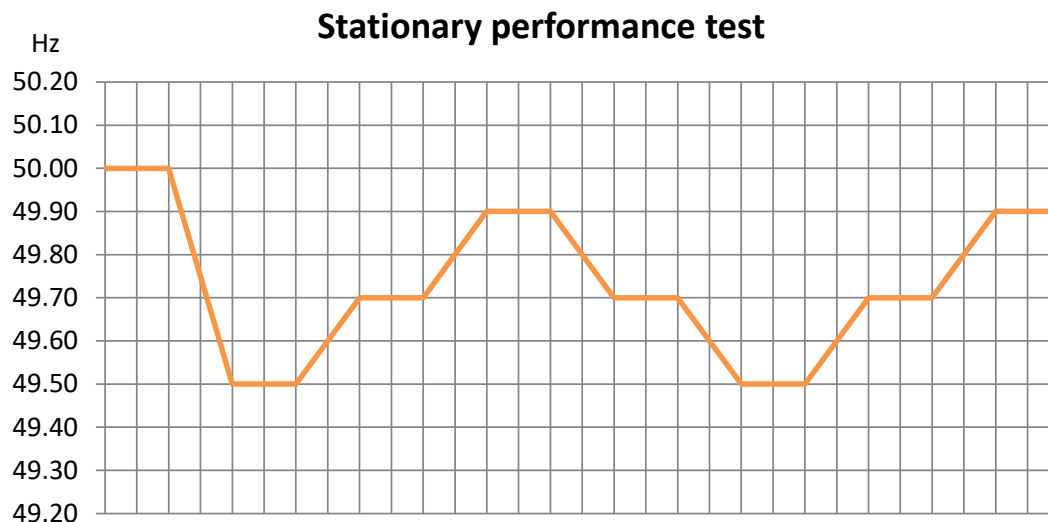

Figure 5. Input frequency signal for FCR-D upwards ramp response tests

3.2.2 FCR-D upwards ramp response test

Ramp tests are performed to assess the FCR-D dynamic performance. Synthetic steps and ramp signals are injected as frequency measurements, giving a power response. The initial two steps (50.00 → 49.80 Hz and 49.80 → 49.90 Hz for FCR-D upwards) are included to highlight the contribution of the backlash when injecting the ramp. The ramp should be at a rate of -0.24 Hz/sec.

50.00 Hz → 49.80 → 49.90 → 49.00 → 49.90

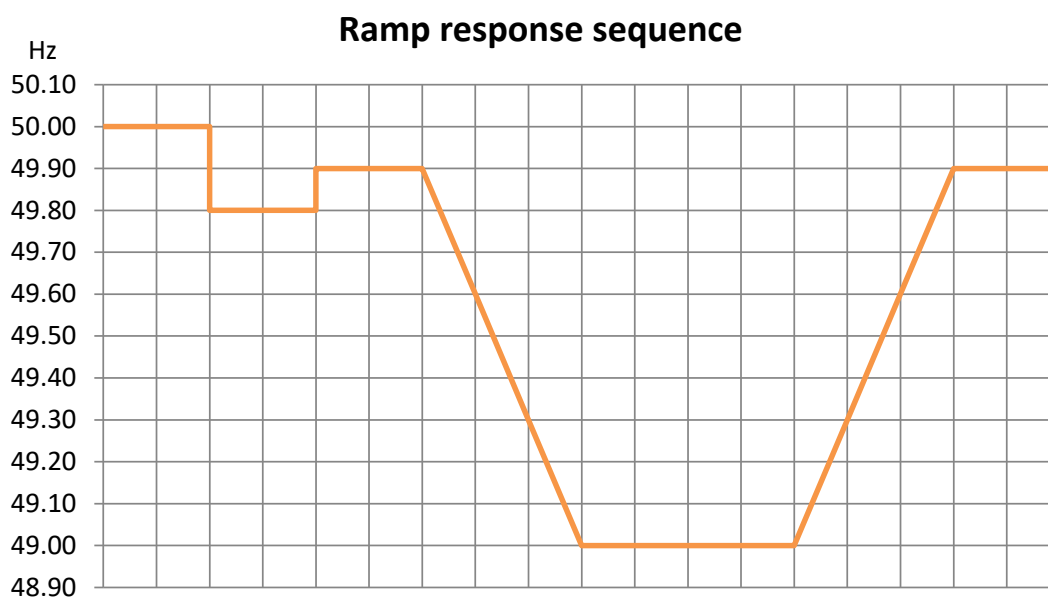

Figure 6. Input frequency signal for FCR-D upwards ramp response tests

3.2.3 FCR-D downwards stationary performance test

A ramp response sequence is performed to determine steady state FCR-D downwards capacity and confirm linear activation of FCR-D. The ramps also provide necessary information about backlash and similar non-linear effects, and can be used for confirming correct switching of parameters between FCR-N and FCR-D.

For FCR providing entities with switching of parameter sets between FCR-N and FCR-D, the initial ramp from 50.00 Hz to 50.50 Hz is used for compliance evaluation, and in that case FCR-N needs to be active. This switchover is only necessary to test (i.e. to keep FCR-N active) at a single power setpoint, but for both droop settings. The step sequence remains the same even if switchover testing is not performed.

Both activation and deactivation shall be tested in the downwards direction. The ramp rate shall be at least 2 mHz/s, i.e. a full activation from 50 Hz to 50.5 Hz shall be made within maximum 250 seconds. A faster ramp rate may be chosen, up to 10 mHz/s, i.e. 50 seconds for full activation.

50.00 Hz → 50.50 → 50.30 → 50.10 → 50.30 → 50.50 → 50.30 → 50.10

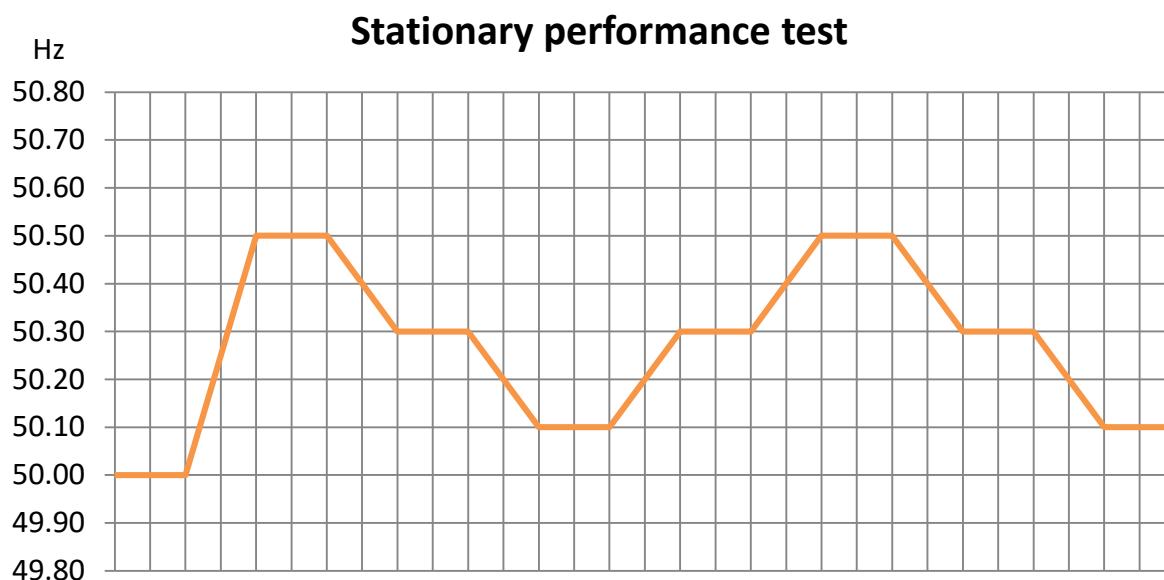

Figure 7. Input frequency signal for FCR-D downwards stationary performance response tests

3.2.4 FCR-D downwards ramp response tests

Ramp tests are performed to assess the FCR-D dynamic performance. Synthetic steps and ramp signals are injected as frequency measurements, giving a power response. The initial two steps (50.00 → 50.20 Hz and 50.20 → 50.10 Hz) are included to highlight the contribution of the backlash when injecting the ramp. The ramp should be at a rate of 0.24 Hz/sec.

50.00 Hz → 50.20 → 50.10 → 51.00 → 50.10

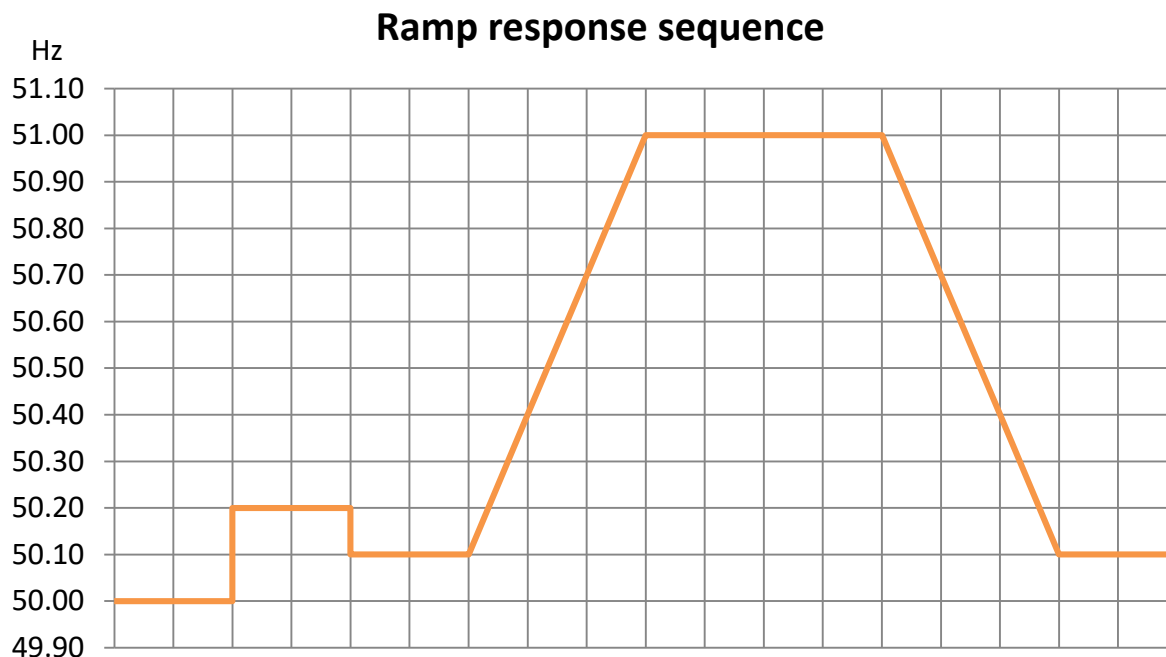

Figure 8. Input frequency signal for FCR-D downwards ramp response tests

3.2.5 FCR-D sine tests

If the same parameter set is used for FCR-D upwards and/or FCR-D downwards, as for FCR-N, the test results from test in section 3.1.2 may be reused.

Sine tests are used to confirm stability. Synthetic sinusoidal frequency signals are injected, which produces a sinusoidal power response. While testing, the frequency input shall be an oscillation around 49.70 Hz (FCR-D upwards) and 50.30 Hz (FCR-D downwards) with an amplitude of 0.1 Hz. Alternatively, if agreed to with the reserve connecting TSO, the test may be performed by a frequency input oscillating around 50.00 Hz whilst providing FCR-response continuously and symmetrically around 50.00 Hz, i.e. by deactivating deadbands/insensitivity used in control loop for FCR-D.

For each time period, at least five periods shall be recorded after reaching a stable sinusoidal active power output. The time periods for which to test is $T = [10, 15, 25, 40, 50]$ seconds. If the response already crosses the real axis ($Im=0$) in the Nyquist plane on the right side of the stability requirement circle for tested time periods, the testing of shorter time periods can be omitted. The FCR provider may choose to perform tests at more time periods to investigate transfer function values in the area otherwise interpolated, see Subsection 4.1

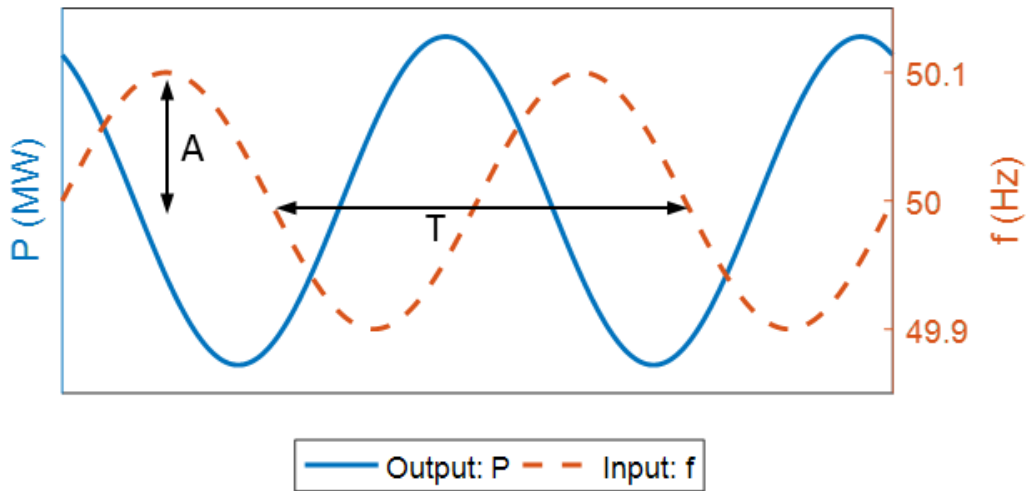

Figure 9. Input frequency signal for FCR-D sine tests

3.3 Special considerations

3.3.1 Separate test of frequency measurement loop

For providers choosing to use an internal software for generating the required test signals, i.e. steps, ramps and sinusoidal signals, the frequency measurement loop must be taken into account by including its properties. This is done by including a time delay corresponding to the frequency measurement loop, T_{FML} .

There are four options for determining the time delay:

1. Separate test of the frequency measurement loop, by inserting an externally generated frequency step response to measure the time constant of the response.

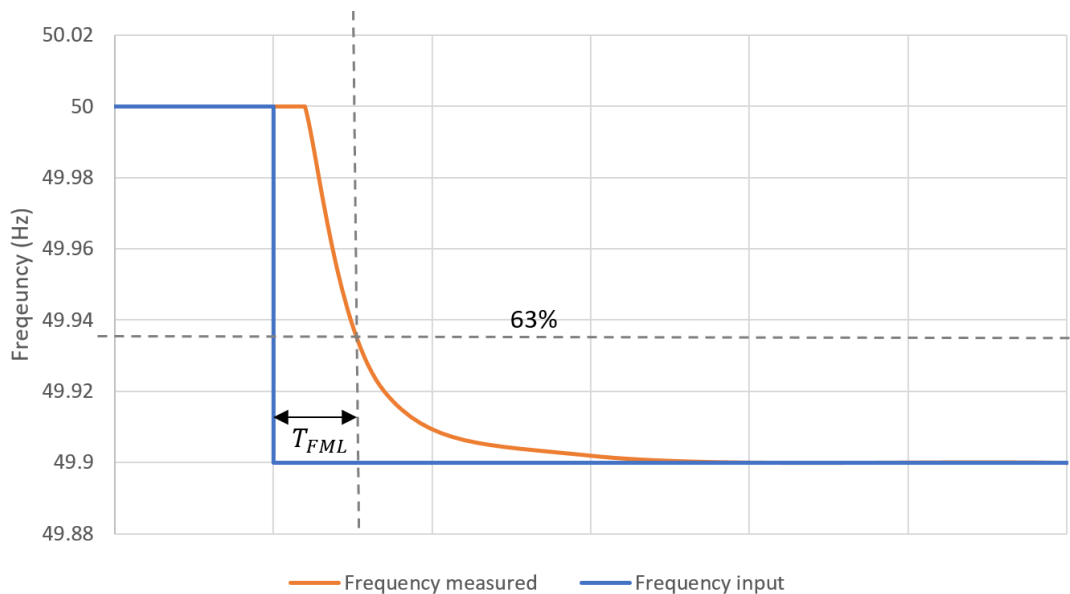

Figure 10 – Example response (blue) from a separate test of frequency measurement loop, by applying a step frequency change (orange)

2. Documentation from supplier of the equipment.

3. References to previous tests of equal equipment.
4. Using the default value provided by the TSOs², $T_{FML} = x$ second (TBD)³.

3.3.2 Linearity test

For entities with a non-continuous response, a linearity test shall be performed to verify compliance with the requirement for linearity.

For FCR-N, the test consists of a sequence of ramps illustrated in Figure 11. At 49.9 Hz and 50.1 Hz respectively, enough waiting time shall be applied such that the response has clearly stabilised, before continuing with the next ramp in the sequence.

50.0 Hz → 49.9 Hz → 50.0 Hz → 50.1 Hz → 50.0 Hz

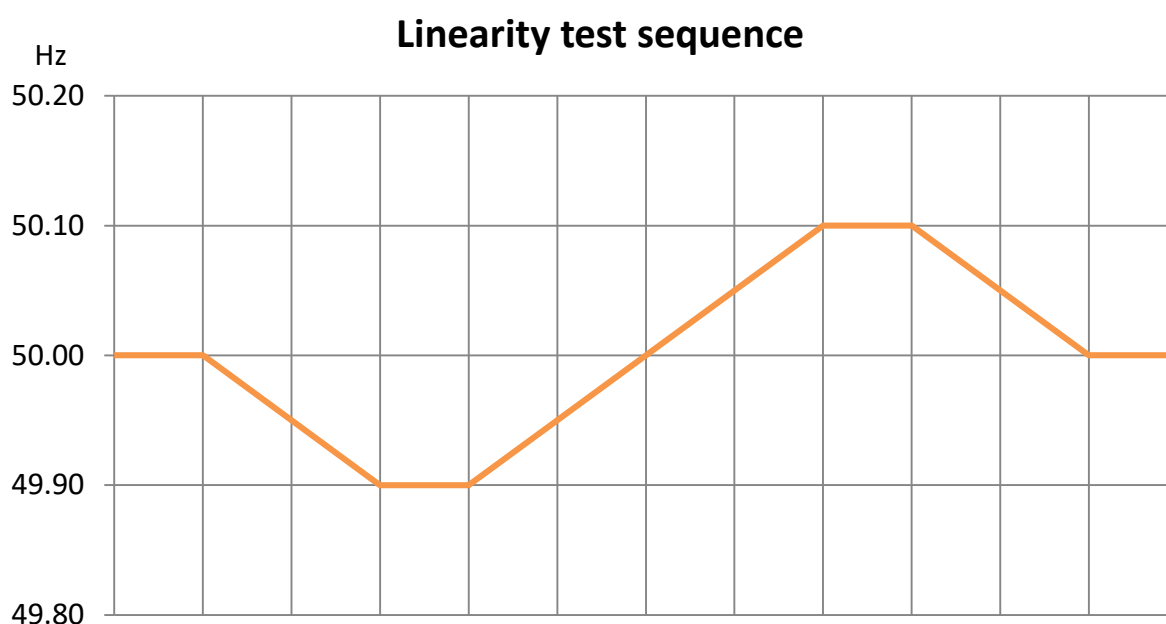

Figure 11. FCR-N linearity test sequence to be performed for minimum and maximum capacity.

Both activation and deactivation shall be tested in the upwards and downwards direction respectively. The ramp rate shall be at least 0.5 mHz/s, i.e. a full activation from 50.0 Hz to 49.9 Hz shall be made within maximum 200 seconds. A faster ramp rate may be chosen, up to 2 mHz/s, i.e. 50 seconds for full activation.

For FCR-D upwards and FCR-D downwards, the linearity is evaluated using the ramp sequence in subsection 3.2.1.

3.3.3 FCR-D with separate high performance and high stability parameters

Instead of using one set of FCR-D parameters that qualifies with all requirements, the provider may choose to use a combination of a *high performance* parameter set and a *high stability* parameter set. The high performance parameters are used to achieve good performance during a frequency disturbance. They are

² The default value is purposefully set to a high value to ensure a margin.

³ The Nordic TSOs are currently working to define the value.

active for a limited time, after which the entity switches to the high stability parameters to ensure stable operation.

When using the high performance parameters, the entity is allowed to have a reduced stability margin, which in turn allows for a faster response. The stability margin, i.e. the radius of the stability margin circle around the Nyquist point, may be reduced maximally to a fourth of the general requirement when applying the high performance parameters. The high stability parameters set must comply with the general stability requirement and with the dynamic performance requirements for FCR-N, as described in the Main document.

FCR-D providing entities utilising separate parameters for high performance and high stability, shall perform separate sine and step testing for each parameter set, with switching disabled. The ramp tests shall be performed per the general instructions, with parameter switching active.

3.3.4 Deactivation

FCR-D providing entities shall fulfil the same requirements for deactivation as stated for activation. The testing is then performed per the general instructions above, where deactivation is tested the same way as activation.

Some FCR-D providing entities will be allowed to exist within a limited quota for entities with a grace period of 15 minutes where the deactivation requirement does not apply, as described in the Main document. Such entities will not be required to perform sine testing. When performing testing on such entities enough resting time shall be applied between each activation in the step and ramp sequences respectively, so that each activation is unhindered by previous activations and the grace period. The detailed testing arrangements for such entities must be agreed with the TSO.

4 Evaluation of compliance

This chapter provides detail on how the requirements should be understood, and how they are evaluated from the test results. The TSOs will provide the necessary IT-tools to automatically perform all calculations and evaluations of test results, and hence this information is provided for those who want to understand the inner workings of that tool, or to create tools of their own.

4.1 Deriving FCR-N and FCR-D transfer function values from testing

The requirements for stability and partially for performance is given by frequency domain criteria. Therefore, the frequency domain response, i.e. the transfer function, of FCR providing entities must be derived. Since not all frequencies are tested, the transfer function is derived by evaluation of tests at specific periods.

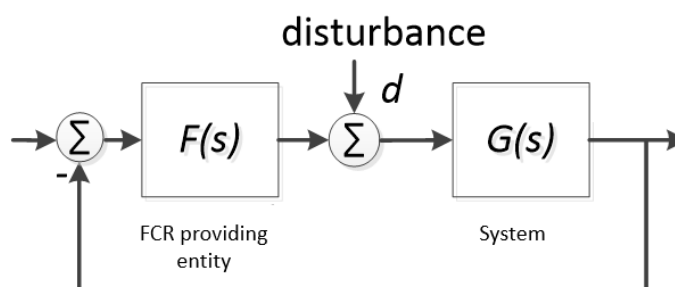

Figure 12: Illustration of the system used for evaluation of compliance with requirements in frequency domain.

The frequency domain requirements are expressed and evaluated assuming linearity of the evaluated system, i.e. no mechanical deadbands/insensitivities/backlash. Such non-linear characteristics may in reality be present in the FCR providing entities being tested. A method to account for these non-linearities is also presented in this section. The method is also applicable should the backlash be zero.

In short, the transfer function is derived by a calculation using

- Step/ramp tests to evaluate backlash and stationary FCR activation
- Sine tests at varying period times to evaluate phase shifts and magnification (damping/amplification) between the injected frequency signal and the FCR response

The transfer function of the FCR providing entity is the curve created by the transfer function values, and the interpolated values between them.

4.1.1 Base values

To calculate the magnification and phase shift, it is necessary to determine what is the stationary active power step response and the backlash scaling factor to compensate for the non-linearity.

Using the test sequences outlined in Section 3 and shown in Figure 13, Figure 14 and Figure 15, the stationary active power step response from a 0.1 Hz step/ramp (A_{step}) is calculated, not including the contribution of the backlash. For FCR-D it is calculated for a 0.2 Hz step.

$$\Delta P_{Normalisation} = \frac{|\Delta P_1| + |\Delta P_3|}{2} [MW] \quad (4.1)$$

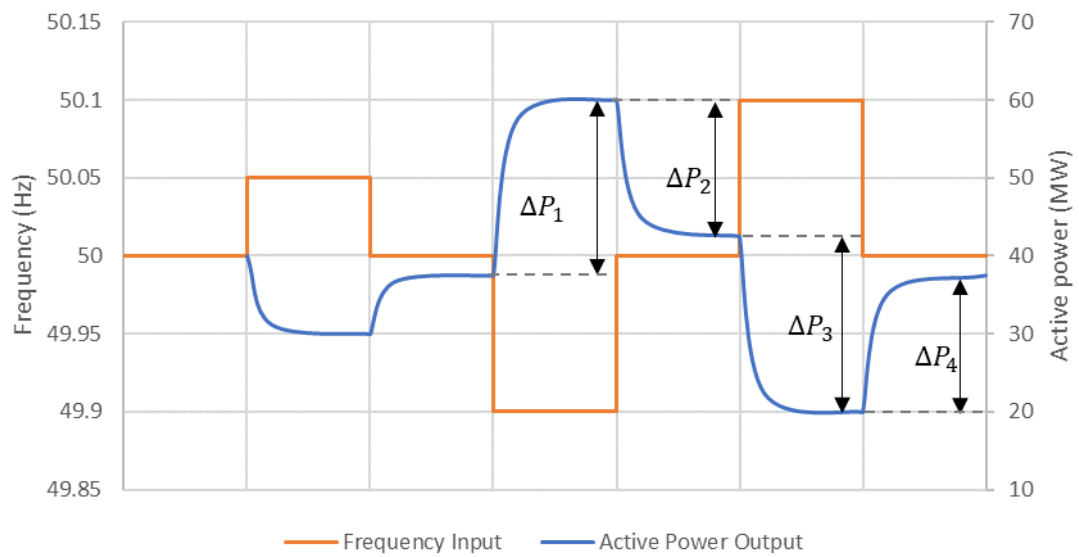

Figure 13. Example response (blue) from input frequency (orange) according to FCR-N step test.

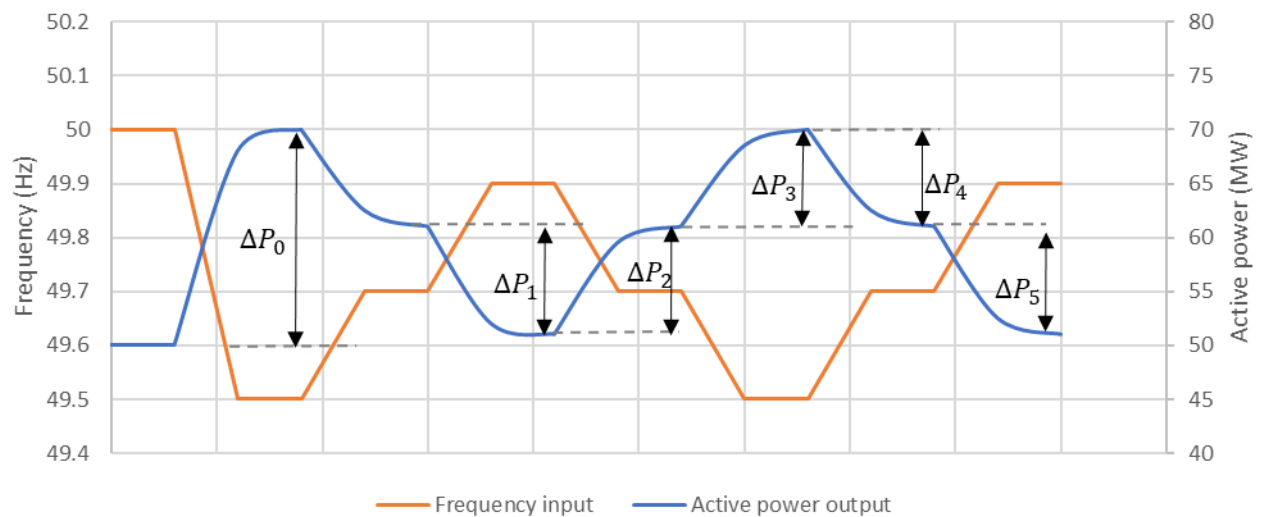

Figure 14. Example response (blue) from input frequency (orange) according to FCR-D upwards stationary performance test

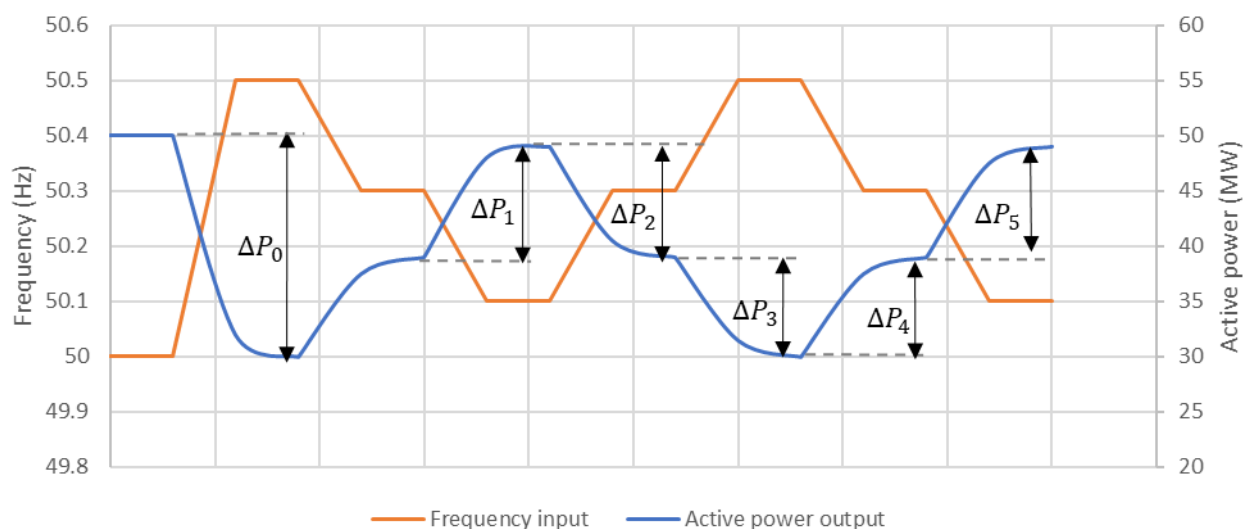

Figure 15. Example response (blue) from input frequency (orange) according to FCR-D downwards stationary performance test.

To account for the backlash, $2D_{pu}$, the results are used to calculate the per unit value as

$$2D_{pu} = \frac{||\Delta P_1| - |\Delta P_2|| + ||\Delta P_3| - |\Delta P_4||}{2 \Delta P_{Normalisation}} [p. u.] \quad (4.2)$$

Based on the total backlash in per unit ($2D_{pu}$), a backlash scaling factor h is obtained from Table 1⁴.

Table 1. Backlash scaling factor (h) as a function of total backlash in per unit ($2D_{pu}$)

$2D_{pu}$	0.00	0.01	0.02	0.03	0.04	0.05	0.06
h	1	0.999	0.998	0.997	0.996	0.994	0.992
$2D_{pu}$	0.07	0.08	0.09	0.10	0.11	0.12	0.13
h	0.99	0.988	0.986	0.984	0.981	0.979	0.976
$2D_{pu}$	0.14	0.15	0.16	0.17	0.18	0.19	0.20
h	0.974	0.971	0.968	0.965	0.962	0.959	0.956
$2D_{pu}$	0.21	0.22	0.23	0.24	0.25	0.26	0.27
h	0.953	0.95	0.946	0.943	0.94	0.936	0.932
$2D_{pu}$	0.28	0.29	0.30				
h	0.929	0.925	0.921				

The backlash factor h , and the steady-state power factor $\Delta P_{Normalisation}$ completes the calculation of the normalisation factor e , used to derive the gain and phase shifts of the sine tests:

$$e = \frac{h \cdot \Delta P_{Normalisation}}{A_{step}} \quad (4.3)$$

⁴ The total backlash is not allowed to be above 0.3 p.u.

4.1.2 Gain and phase shift

A transfer function value can be defined as

- The gain that describes the magnification of the output relative to the input signal, and;
- The time shift that describes the phase shift of the output relative to the input signal.

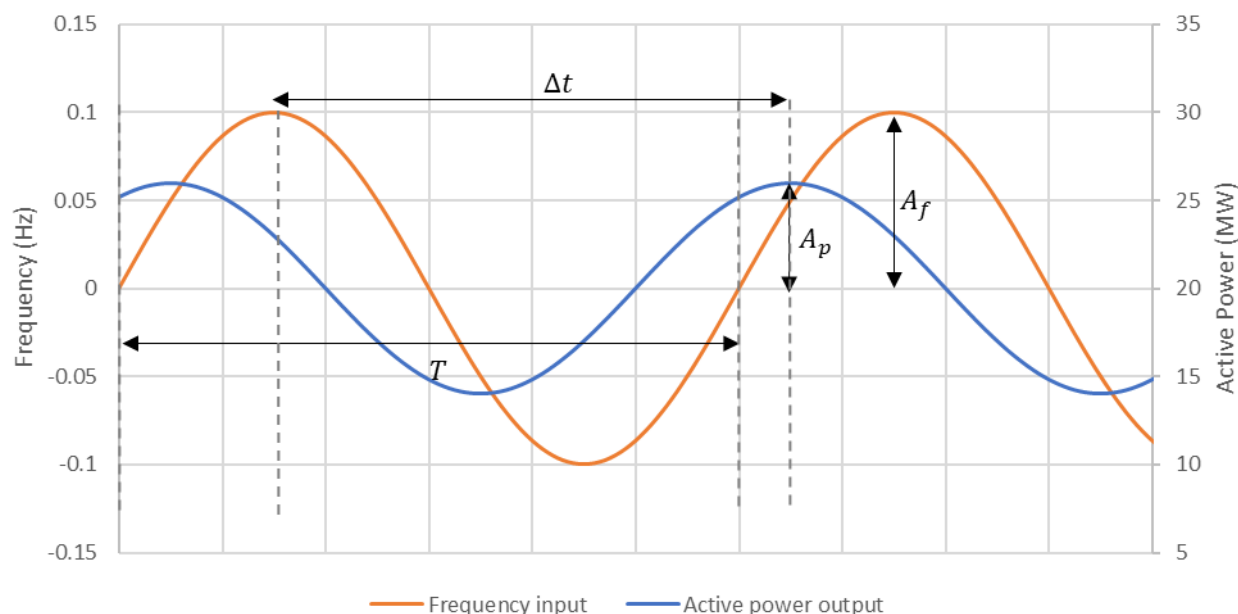

Figure 16. Example response (blue) from input frequency (orange) for FCR sine test

The angular frequency corresponding to a certain time period, T , can be calculated as

$$\omega = \frac{2\pi}{T} \quad (4.4)$$

The gain in per unit is calculated as

$$|F(j\omega)| = \frac{A_p}{e A_f} \quad (4.5)$$

Where A_p is the amplitude of the power output (MW), A_f is the amplitude of the frequency input and e is the normalization factor.

The phase φ (*degrees*) of the transfer function for a certain angular frequency/time period is calculated as

$$\varphi = \mathbf{Arg}(F(j\omega)) = \Delta t \frac{360^\circ}{T} \quad (4.6)$$

where T is the time period (s) and Δt is the time difference (s) of the input frequency signal and output power signal, as shown in Figure 16.

When evaluating compliance, the transfer function values of the FCR providing entity is used together with the transfer function values for the model of the power system, $G(s)$. Note that $G(s)$ is different

between FCR-N and FCR-D, and between stability and performance for FCR-N, due to different dimensioning inertia-levels and regulating strengths in the system. The gain and phase shift for the power system transfer function is calculated without use of measurements. Equations (4.7) and (4.8) show the transfer functions for FCR-N and FCR-D respectively. The values used for stability and performance are provided in sections 4.2.2, 4.2.3 and 4.3.4.

$$G(j\omega) = \frac{600 \text{ MW } f_0}{0.1 \text{ Hz } S_n} \frac{1}{2Hj\omega + K_f f_0} [\text{p.u.}] \quad (4.7)$$

$$G(j\omega) = \frac{1450 \text{ MW } f_0}{0.4 \text{ Hz } S_n} \frac{1}{2Hj\omega + K_f f_0} [\text{p.u.}] \quad (4.8)$$

Where

$\omega = \frac{2\pi}{T}$ and T is the tested time periods.

f_0 is the nominal frequency, 50 Hz

k_f is the load frequency dependency

H is the inertia constant of the Nordic power system

S_n is the nominal power of the Nordic power system

In addition, the transfer function values of the dimensioning disturbance profile for FCR-N performance, $D(s)$, is calculated for the tested period times. It is derived from the characteristics of the system imbalances/disturbances, expressed by the transfer function in equation (4.9), using a time constant of 70 seconds.

$$|D(j\omega)| = \left| \frac{1}{70j\omega + 1} \right| \quad (4.9)$$

An example of the results after calculating gain and phase shift for each tested time period is given in Table 2, for FCR-N. Note that only the white cells are derived from testing, while all others are theoretical values, which are equal for every test. Table 3 shows the transfer function values based on testing in combination with the theoretically derived transfer function values for the power system transfer function.

Table 2. Example values for calculation of transfer function values for FCR-N providing entity and for power system

Period time, T (s)	$F(j\omega)$		$G_{min}(j\omega)$ (stability)		$G_{avg}(j\omega)$ (performance)	
	$ F(j\omega) $	$\arg(F(j\omega))$ (degrees)	$ G_{min}(j\omega) $	$\arg(G_{min}(j\omega))$ (degrees)	$ G_{avg}(j\omega) $	$\arg(G_{avg}(j\omega))$ (degrees)
10	0.2340	87.5660	1.9808	-87.8163	1.2517	-84.9735
15	0.2194	104.2934	2.9793	-86.7265	1.8685	-82.4843
25	0.2161	117.3542	4.9511	-84.5546	3.0679	-77.5989
40	0.2278	122.6276	7.8668	-81.3279	4.7411	-70.6173
50	0.2404	123.5015	9.7712	-79.2059	5.7509	-66.2615
60	0.2553	123.7382	11.6360	-77.1134	6.6675	-62.1783
70	0.2721	123.7617	13.4550	-75.0552	7.4897	-58.3803

Using the transfer function values, the results can be combined to calculate the transfer functions for evaluation of compliance. The needed information is the real part, the imaginary part and the gain of the

inverse of the sensitivity transfer function $\frac{1}{S(j\omega)}$ and the gain of closed loop transfer function values, $G(j\omega)S(j\omega)$.

The last column of Table 3 is the distance to the Nyquist point, as illustrated in Figure 17. Note that the transfer function value of infinitely high frequency/low time period is included in the figure, in transfer function value given by (0,0), and that the interpolated values between that and the 10 second period time transfer function value, illustrated by a green dashed line, is included in the evaluation of compliance.

Table 3. Example values for calculation of transfer function values for compliance evaluation of FCR-N stability

Period time, T (s)	Real part of inverse of sensitivity transfer function, $Re\{1 - F(j\omega)G_{min}(j\omega)\}$	Imaginary part of inverse of sensitivity transfer function, $Im\{1 - F(j\omega)G_{min}(j\omega)\}$	Gain of the inverse sensitivity function $ 1 - F(j\omega)G_{min}(j\omega) $
0	0	0	0
10	0.5349	0.0020	0.5349
15	0.3768	-0.1973	0.4253
25	0.1008	-0.5795	0.5882
40	-0.3465	-1.1829	1.2326
50	-0.6812	-1.6403	1.7761
60	-1.0404	-2.1596	2.3971
70	-1.4158	-2.7504	3.0934

Table 4. Example values for calculation of transfer function values for compliance evaluation of FCR-N performance requirement

Period time, T (s)	Closed loop transfer function, $S(j\omega)G(j\omega) = \left \frac{G_{avg}(j\omega)}{1 - F(j\omega)G_{avg}(j\omega)} \right $	Disturbance profile, $\frac{1}{ D(j\omega) }$
10	1.7690	43.9937
15	2.9296	29.3386
25	4.7328	17.6213
40	5.1822	11.041
50	4.8346	8.8531
60	4.4188	7.3983
70	4.0296	6.3623

Figure 17 illustrates the Nyquist-curve and Figure 18 the closed loop transfer function values in relation to the requirements. When evaluating the requirements in Figure 17 and Figure 18, a 5 % tolerance will be applied to take into account measurement uncertainties, etcetera. The tolerance is seen in Figure 17 as the shaded blue area around the requirement, after the tolerance has been applied by scaling the requirement with 0.95. The tolerance is included in the dashed line of Figure 18 by scaling the requirement with 1/0.95. The tolerance has not been included in Table 2, Table 3, or Table 4.

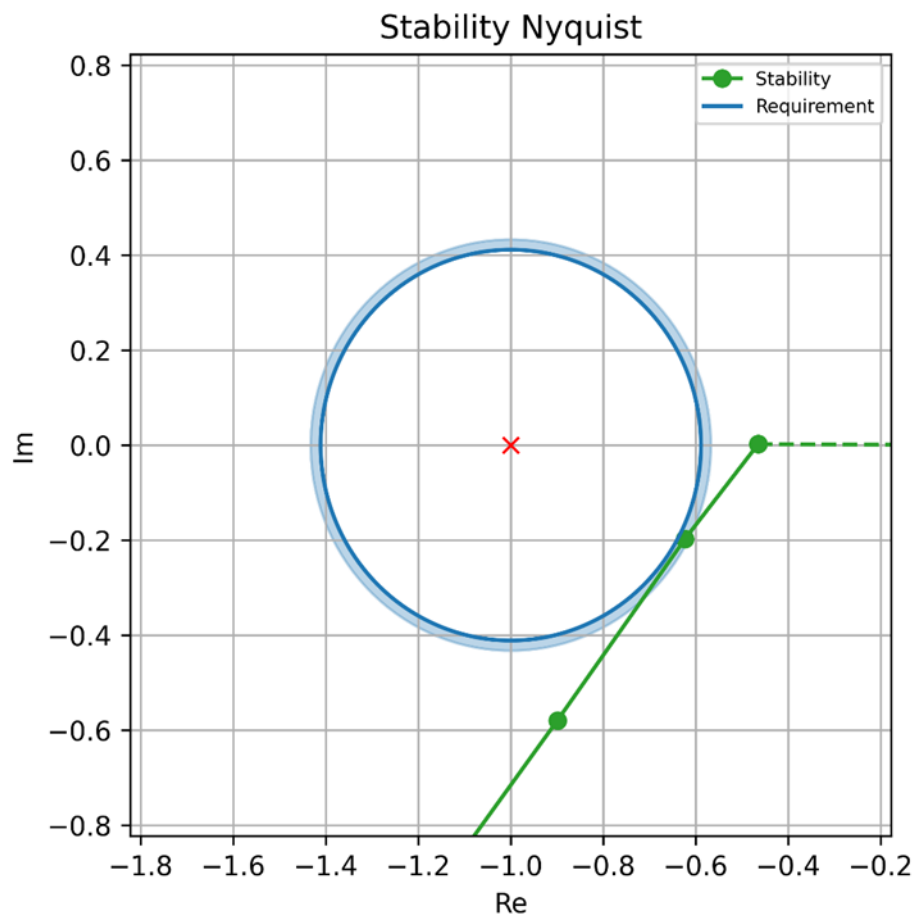

Figure 17. Example response of transfer function values (green dots) and transfer function (green line) of the open loop response, given by second and third column of Table 3, which qualifies for the stability margin requirement (blue circle of radius $r = \frac{1}{M_{s,req}} = 0.43$) and does not enclose the point (-1,0) (red cross).

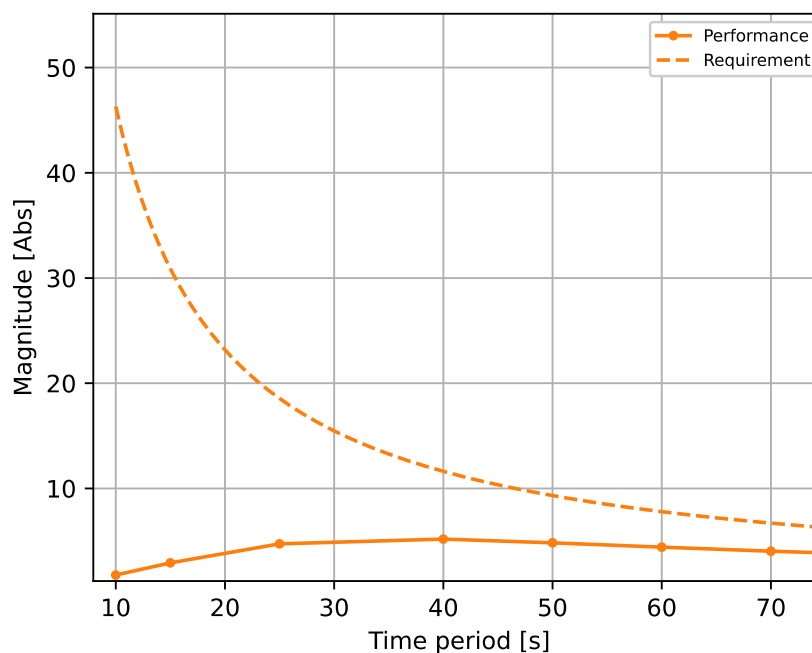

Figure 18. Example response of transfer function values (orange dots), transfer function (orange solid line) of the closed loop response, given by second column of Table 4, which qualifies for the performance requirement (orange dashed line), given by third column of Table 4.

4.1.3 Frequency measurement loop

If tests are done using internal software in the governor for generating test signals, and thus not including the frequency measurement loop, this must be accounted for in the calculation the transfer function.

The approximate frequency measurement loop impact, as determined by section 3.3.1, is included in the FCR providing entities transfer function as a first order filter with a time constant T_{FML} , as shown in equation (4.10).

$$F(s) = \frac{1}{T_{FML}s + 1} F'(s) \quad (4.10)$$

Where $F'(s)$ is the transfer function not including the frequency measurement loop.

When calculating the transfer function values for the FCR providing entity, the transfer function values derived from sine testing are multiplied with transfer function values of the first order filter for the respective time periods tested.

$$F(j\omega) = \frac{1}{T_{FML}j\omega + 1} F'(j\omega) \quad (4.11)$$

4.2 Evaluation of FCR-N requirements

4.2.1 Evaluation of FCR-N requirement for stationary activation

The capacity of an FCR-N providing entity is determined based on the step response sequence measurement outlined in Subsection 3.1.1 and examples of the response is shown in Figure 19.

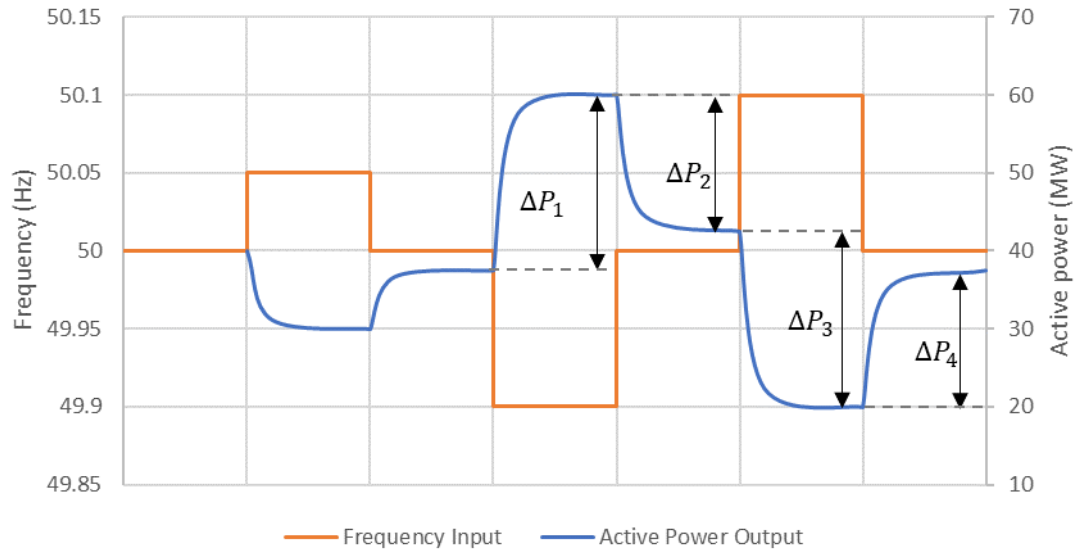

Figure 19. Example response (blue) from input frequency (orange) according to FCR-N step test

First, the total backlash is calculated as

$$2D = \frac{||\Delta P_1| - |\Delta P_2|| + ||\Delta P_3| - |\Delta P_4||}{2} \quad (4.12)$$

and the resulting FCR-N stationary capacity is, assuming compliance with performance and stability

$$C_{FCR-N} = \frac{|\Delta P_1| + |\Delta P_3| - 2D}{2} \quad (4.13)$$

Linear response upwards and downwards is confirmed by comparing the steps in each direction

$$\frac{||\Delta P_1| - |\Delta P_3||}{C_{FCR-N}} < 0.1 \quad (4.14)$$

4.2.2 Evaluation of FCR-N requirement for dynamic performance

The dynamic performance requirements are confirming that the stationary capacity is activated correctly. For the steps from illustrated in Figure 19, following three requirements shall be fulfilled for all four steps:

1. $|\Delta P_{60s}| \geq 0.63 \cdot |\Delta P_{ss}|$
2. $|\Delta P_{180s}| \geq 0.95 \cdot |\Delta P_{ss}|$
3. $|E_{60s}| \geq 24 \text{ s} \cdot |\Delta P_{ss}|$

In the equations above;

ΔP_{60s} is the activated power 60 seconds after applying the step signal

ΔP_{180s} is the activated power 180 seconds after applying the step signal

ΔP_{ss} is the steady state FCR-N activation, i.e. the value where the power stabilizes, of the steps in the test illustrated in Figure 19 $\Delta P_1, \Delta P_2, \Delta P_3$ and ΔP_4 .

E_{60s} is the activated energy 60 seconds after applying the step signal

$$E_{60s} = \int_{t_{step}}^{t_{step}+60s} \Delta P(t) dt \quad (4.15)$$

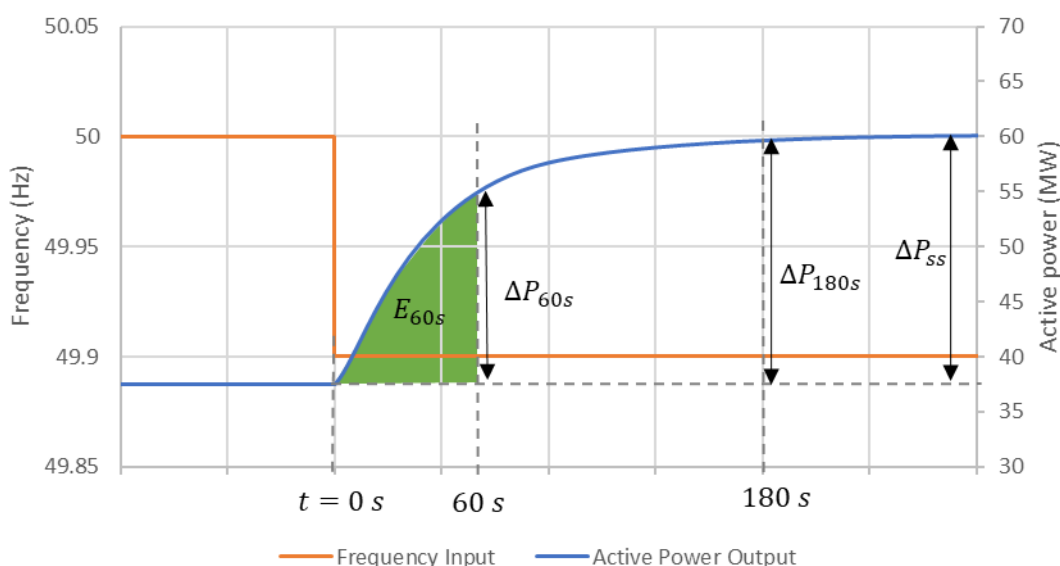

Figure 20. Example response of a single step, blue, from input frequency, orange, according to FCR-N step test from 50 to 49.9 Hz

Compliance with the FCR-N dynamic performance requirement is also evaluated in frequency domain by comparing the FCR providing entities response with the required system response. $F(s)$ is the transfer function of the FCR providing entity, derived as described in Subsection 4.1. Note that the requirement applies also to the interpolated values between the tested period times. The performance requirement is

$$\left| \frac{G_{avg}(s)}{1 - F(s)G_{avg}(s)} \right| < \left| \frac{1}{D(s)} \right| \quad (4.16)$$

Where s is the Laplace operator and $\mathbf{F}(s)$ is in per unit. And

$$G(s) = \frac{600 \text{ MW}}{0.1 \text{ Hz}} \frac{f_0}{S_{n,avg}} \frac{1}{2H_{avg}s + K_{f,avg} \cdot f_0} = \frac{7.14}{9.048 s + 0.5} \quad (4.17)$$

$$\left| \frac{1}{D(s)} \right| = |73.5 s + 1.05| \quad (4.18)$$

f_0 is the nominal frequency 50 Hz

$S_{n,avg}$ is the nominal power of the Nordic power system for average inertia level, 42 000 MW

$H_{n,avg}$ is the inertia constant of the power system for average inertia level, $\frac{190\,000 \text{ MWs}}{S_{n,nom}}$

$K_{f,avg}$ is the load frequency dependence 0.01

The compliance evaluation can be visualized as Figure 21. Other visualisations may also add value for providers evaluating the FCR proving entity during analyses or tuning. See appendices for details.

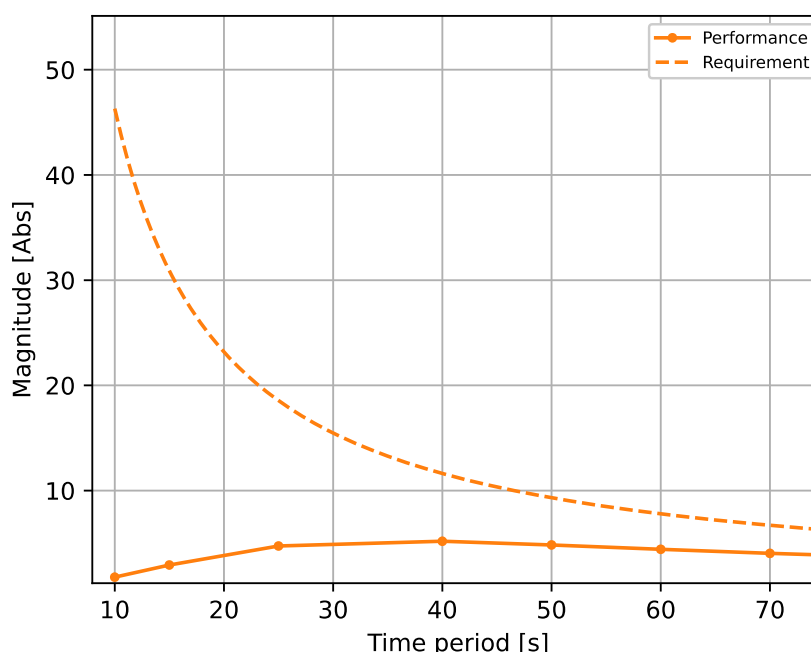

Figure 21. Example response of transfer function values (orange dots), transfer function (orange solid line) of the closed loop response which qualifies for the performance requirement (orange dashed line).

4.2.3 Evaluation of FCR-N requirement for dynamic stability

The dynamic stability requirements are confirming that the response of the FCR provision is contributing correctly to damp frequency oscillations in the system.

Compliance with the FCR-N dynamic stability requirement is evaluated using the Nyquist-criteria for the open loop transfer function, given by equations (4.19) and (4.20). $F(s)$ is the transfer function of the FCR providing entity, derived as described in section in Subsection 4.1. Note that the requirement applies also to the interpolated values between the tested period times.

$$|1 - F(s)G_{\min}(s)| < \left| \frac{1}{M_s} \right| \quad (4.19)$$

$$\text{Re}\{1 - F(s)G_{\min}(s)\} > -1 \text{ when } \text{Im}\{1 - F(s)G_{\min}(s)\} = 0 \quad (4.20)$$

Where,

$$G_{min}(s) = \frac{600 \text{ MW}}{0.1 \text{ Hz}} \frac{f_0}{S_{n,min}} \frac{1}{2H_{min}s + K_{f,min} \cdot f_0} = \frac{13.04}{10.43 s + 0.25} \text{ [p.u.]} \quad (4.21)$$

and,

M_s is 2.31, the maximum sensitivity

s is the Laplace operator

f_0 is 50 Hz

$S_{n,min}$ is 23 000 MW

H_{min} is $\frac{120\,000 \text{ MWh}}{S_{n,min}}$

$K_{f,min}$ is 0.005 (the load frequency dependence)

$F(s)$ given in per unit.

The Nyquist-diagram can be visualized as in Figure 22, also shown in the Main document. The graphical representation of the stability criteria, is that the Nyquist-curve created by the transfer function values and the interpolation between them, should not enclose the point (-1,0) and should not pass inside the stability margin circle.

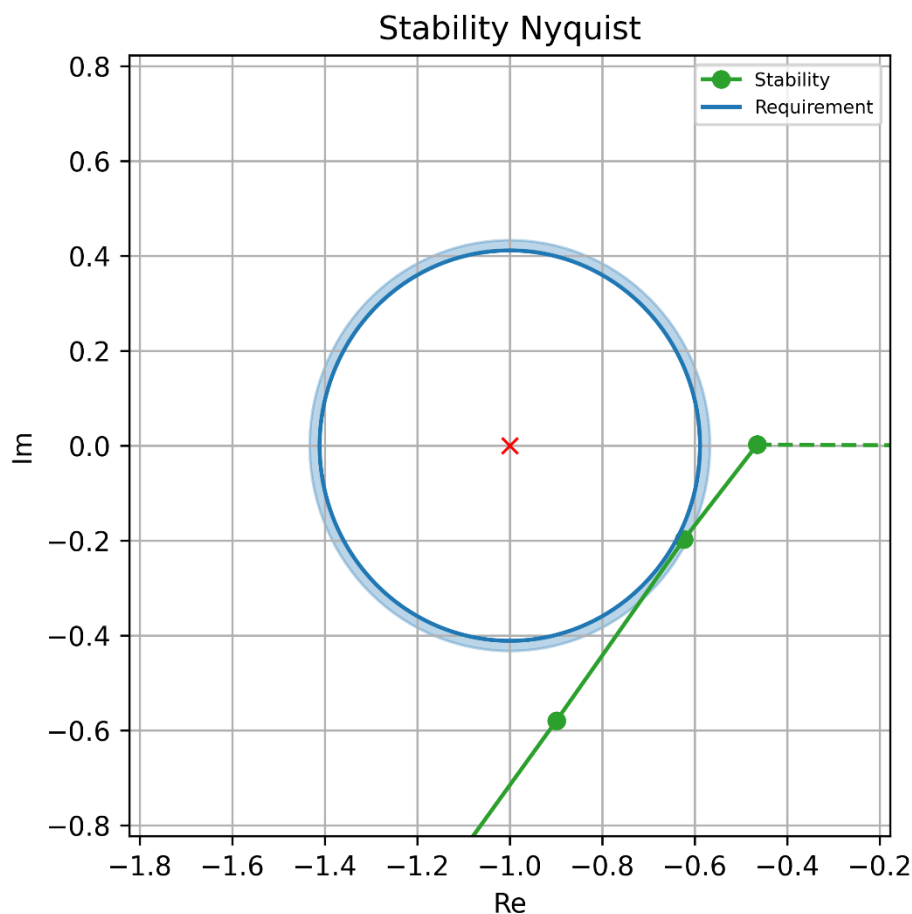

Figure 22. Nyquist diagram of the Nyquist-point (-1,0), FCR-N stability margin requirement (blue) together with an example response (green).

4.3 Evaluation of FCR-D requirements

4.3.1 Evaluation of FCR-D requirements for stationary activation

The capacity of an FCR-D upwards providing entity is determined based on the ramp response sequence measurement outlined in Subsection 3.2.1 and shown in Figure 23, and for an FCR-D downwards providing entity is determined based on the ramp response sequence measurement outlined in Subsection 3.2.3 and shown in Figure 24.

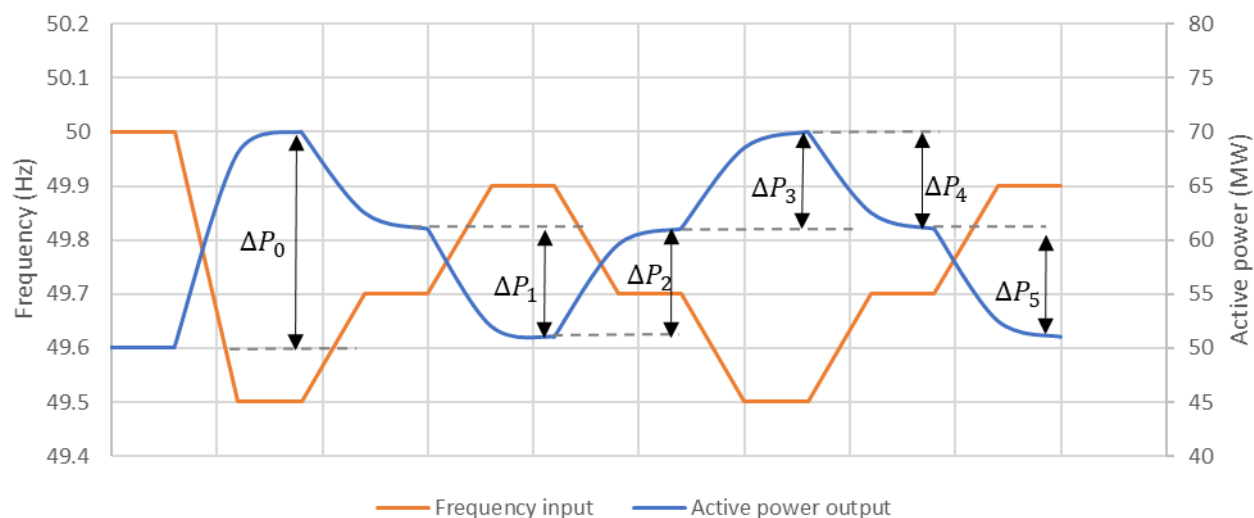

Figure 23. Example response (blue) from input frequency (orange) according to FCR-D upwards stationary performance test

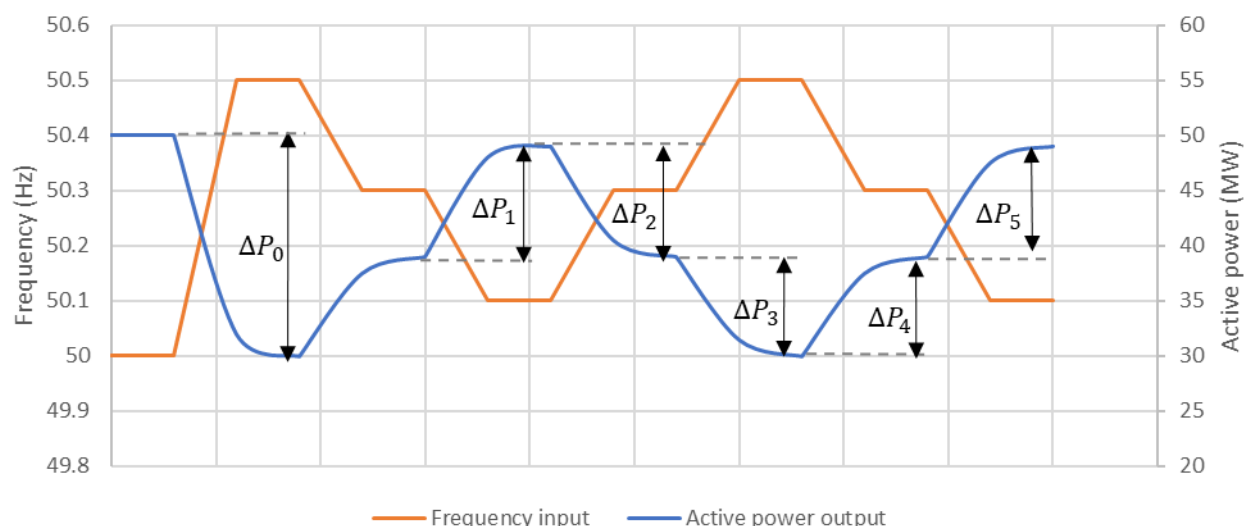

Figure 24: Example response (blue) from input frequency (orange) according to FCR-D downwards stationary performance test

The FCR-D upwards and FCR-D downwards steady-state activation can be calculated as

$$\Delta P_{ss,upwards/downwards} = |\Delta P_2 + \Delta P_3| \quad (4.22)$$

Linear response for activation and deactivation is confirmed by comparing the responses in each direction

$$\frac{||\Delta P_2 + \Delta P_3| - |\Delta P_4 + \Delta P_5||}{\Delta P_{ss,upwards/downwards}} < 0.1 \quad (4.23)$$

4.3.2 Evaluation of FCR-D requirements for dynamic performance

The FCR-D dynamic performance is evaluated using the ramp tests in Subsection 3.2.2 and 3.2.4. The FCR-D upwards entity is subjected to a frequency input ramp from 49.9 Hz to 49.0 Hz with a slope of -0.24 Hz/s for FCR-D upwards. The FCR-D downwards entity is subjected to a frequency input ramp from 50.1 Hz to 51.0 Hz with a slope of 0.24 Hz/s.

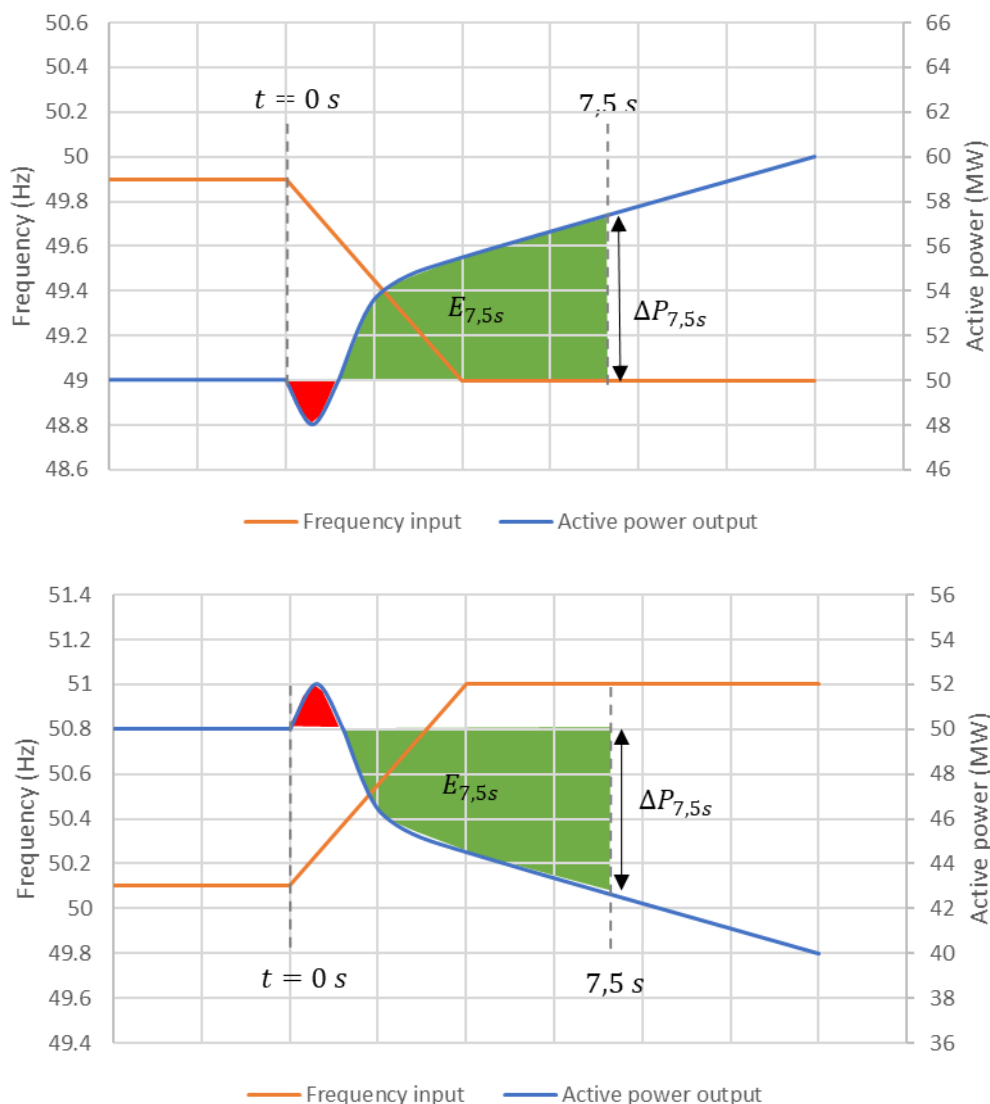

Figure 25. Calculation of FCR-D upwards capacity and FCR-D downwards capacity. The green area indicates positive energy contribution while the red area indicates negative energy contribution.

Using the values as illustrated in Figure 25, the following requirements shall be fulfilled for the ramp response:

1. $|\Delta P_{7,5s}| \geq 0.93 \cdot |\Delta P_{ss}|$ (MW)
2. $|E_{7,5s}| \geq 3.7s \cdot |\Delta P_{ss}|$ (MWs)

where

$\Delta P_{7,5s}$ is the activated power 7.5 seconds after the start of the ramp

ΔP_{ss} is the steady state FCR-D activation calculated in subsection 4.3.1.

$E_{7.5s}$ is the activated energy from the start of the ramp to 7.5 seconds after the start of the ramp, that is

$$E_{7.5s} = \int_t^{t+7.5s} \Delta P(t) dt \quad (4.24)$$

If the FCR providing entity does not fulfil the performance requirement, it can still provide the partial compliant provision. I.e., the FCR-D capacity, C_{FCR-D} , is minimum of the three requirements for power activation performance, stationary performance and energy supplement performance.

$$C_{FCR-D \text{ upwards/downwards}} = \min \left(\left| \frac{\Delta P_{7.5s}}{0.93} \right|, \left| \Delta P_{ss, \text{upwards/downwards}} \right|, \left| \frac{E_{7.5s}}{3.7s} \right| \right) \quad (4.25)$$

4.3.3 Evaluation of FCR-D requirements for dynamic performance for deactivation

The FCR-D deactivation performance will be evaluated similar to the evaluation of activation performance in subsection 4.3.2, unless a grace time is given in accordance with subsection 3.3.4.

4.3.4 Evaluation of FCR-D requirements for dynamic stability

The dynamic stability requirements are confirming that the response of the FCR-D provision is contributing correctly to damp frequency oscillations in the system.

Compliance with the FCR-D dynamic stability requirement is evaluated using the Nyquist-criteria for the open loop transfer function, given by equations (4.26) and (4.27). $F(s)$ is the transfer function of the FCR providing entity, as described in section 4.1. Note that the requirement applies also to the interpolated values between the tested period times.

$$|1 - F(s)G_{min}(s)| < \left| \frac{1}{M_s} \right| \quad (4.26)$$

$$\text{Re}\{1 - F(s)G_{min}(s)\} > -1 \text{ when } \text{Im}\{1 - F(s)G_{min}(s)\} = 0 \quad (4.27)$$

Where

$$G_{min}(s) = \frac{\Delta P_{ss}}{C_{FCR-D}} \frac{1450 \text{ MW}}{0.4 \text{ Hz}} \frac{f_0}{S_{n, \min}} \frac{1}{2H_{\min}s + K_{f, \min} \cdot f_0} = \frac{\Delta P_{ss}}{C_{FCR-D}} \frac{7.88}{10.43s + 0.25} \text{ [p.u.]} \quad (4.28)$$

For FCR-D upwards and FCR-D downwards. And,

M_s is 2.31

s is the Laplace operator

f_0 is 50 Hz

$S_{n, \min}$ is 23 000 MW

H_{\min} is $\frac{120\,000 \text{ MWs}}{S_{n, \min}}$

$K_{f, \min}$ is 0.005 (the load frequency dependence)

$F(s)$ is given in per unit.

ΔP_{ss} is the steady state FCR-D upwards or downwards activation

C_{FCR-D} is FCR-D upwards or downwards capacity (see Equation (4.25)).

Compared to stability evaluation for FCR-N, the factor $\frac{\Delta P_{ss}}{C_{FCR-D}}$ is included to account for possible performance scaling, and is applicable in cases where the FCR providing entity is unable to fully comply with the performance criteria, but is allowed to sell the part of the stationary capacity under the precondition that it is accounted for in the stability evaluation.

The Nyquist-diagram can be visualized as in Figure 26. The graphical representation of the stability criteria, is that the Nyquist-curve created by the transfer function values and the interpolation between them, should not enclose the point (-1,0) and should not pass inside the stability margin circle.

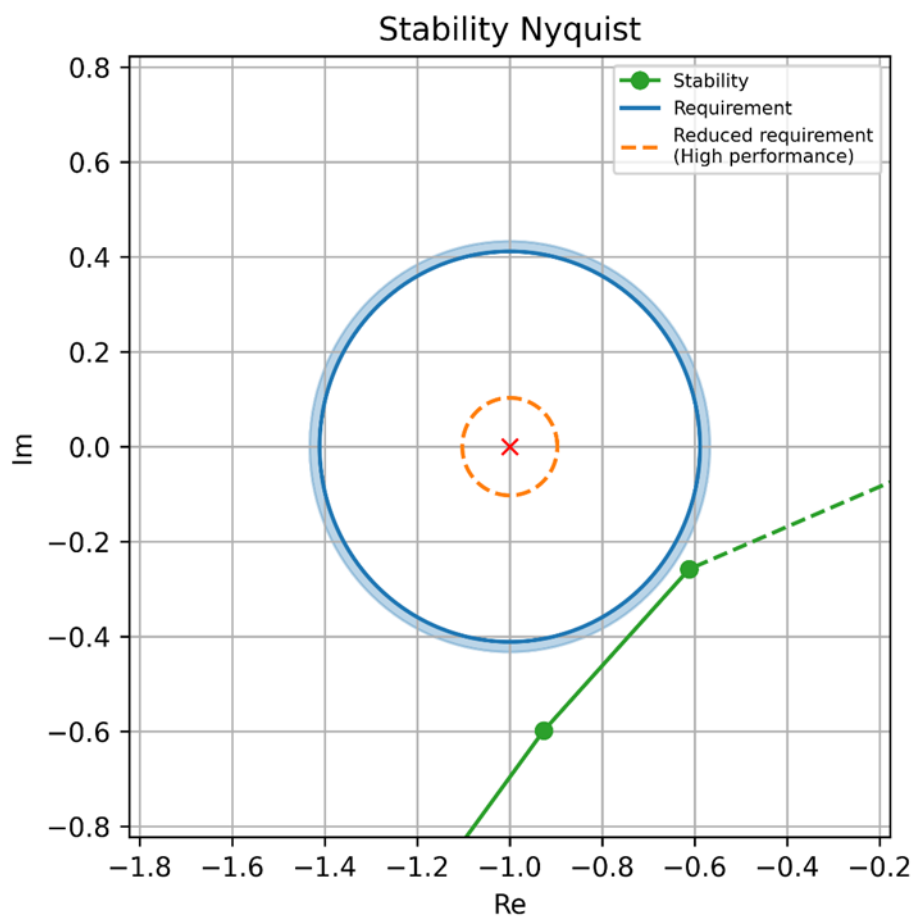

Figure 26. Illustration of FCR-D stability requirement (blue) together with an example response (green). The example response fulfils the stability requirement since it does not enter the blue circle or encircle the red cross. The orange circle indicates the reduced stability requirement for entities utilising high performance parameters in accordance with subsection 3.3.3.

4.4 Evaluation of requirement of switch over between FCR-N and FCR-D

Requirements for entities providing both FCR-N and FCR-D by switching of parameters is verified by documenting the stationary delivery of the entity at 49.5 Hz or 50.5 Hz for FCR-D upwards and FCR-D downwards respectively. The total stationary FCR response shall be equal to the sum of the two individual stationary responses of FCR-N and FCR-D with their respective parameter sets.

Referring to Subsection 3.1.1, 3.2.1, and 3.2.3 the relevant values are found from the stationary performance tests results illustrated in Figure 19, Figure 23 and Figure 24.

The verification criteria for the simultaneous provision of FCR-N and FCR-D upwards, referring to Table 5, is given as

$$|\Delta P_0| - |\Delta P_2 + \Delta P_3| - |\Delta P_1| < 0.05 \cdot |\Delta P_0| \quad (4.29)$$

The verification criteria for the simultaneous provision of FCR-N and FCR-D downwards, referring to Table 6, is given as

$$|\Delta P_0| - |\Delta P_2 + \Delta P_3| - |\Delta P_3| < 0.05 \cdot |\Delta P_0| \quad (4.30)$$

Table 5. Relevant values for showing compliance for switching between FCR-N and FCR-D upwards

Relevant test results	Value	Notation referring to figures
From Figure 23 (FCR-D upwards)	Combined FCR-N and FCR-D steady state activation	$ \Delta P_0 $
From Figure 23 (FCR-D upwards)	FCR-D steady state activation	$ \Delta P_2 + \Delta P_3 $
From Figure 19 (FCR-N)	FCR-N stationary capacity	$ \Delta P_1 $

Table 6. Relevant values for showing compliance for switching between FCR-N and FCR-D downwards

Relevant test	Value	Notation referring to figures
From Figure 24 (FCR-D downwards)	Combined FCR-N and FCR-D steady state activation	$ \Delta P_0 $
From Figure 24 (FCR-D downwards)	FCR-D steady state activation	$ \Delta P_2 + \Delta P_3 $
From Figure 19 (FCR-N)	FCR-N stationary capacity	$ \Delta P_3 $

4.5 Evaluation of linearity requirement

For FCR providing entities performing the linearity tests of section 3.3.2, the compliance is evaluated by confirming that the measurement results are in line with the linearity requirement, i.e. that the response is within the blue area of the requirement.

The measured FCR response scaled by the capacity shall be plotted against the instantaneous frequency deviation. For FCR-N, this is illustrated in Figure 27 with the linearity requirement indicated by the blue

area. The coordinates of the blue area are given in Table 7. Note that the actual test will contain more data-points.

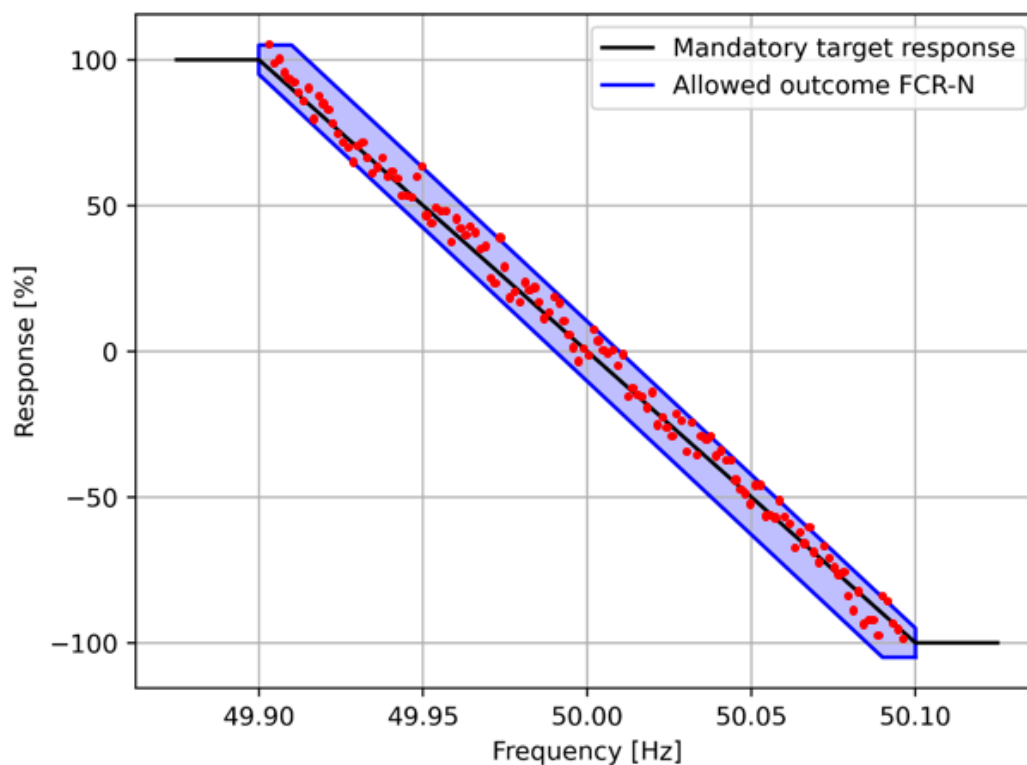

Figure 27. Example response (red dots) of stationary activation of FCR-N for an FCR providing entity, compared to requirement for linearity (blue area).

Table 7. Coordinates of the corners in Figure 27.
Counter-clockwise starting from the minimum activation at 49.9 Hz.

Frequency [Hz]	Response [%]
49.90	95
49.90	105
49.91	105
50.10	-95
50.10	-105
50.09	-105
49.90	95

Similarly, the plot for FCR-D is illustrated in Figure 28 with the linearity requirement described by Table 8. Note that the actual test will contain more data-points.

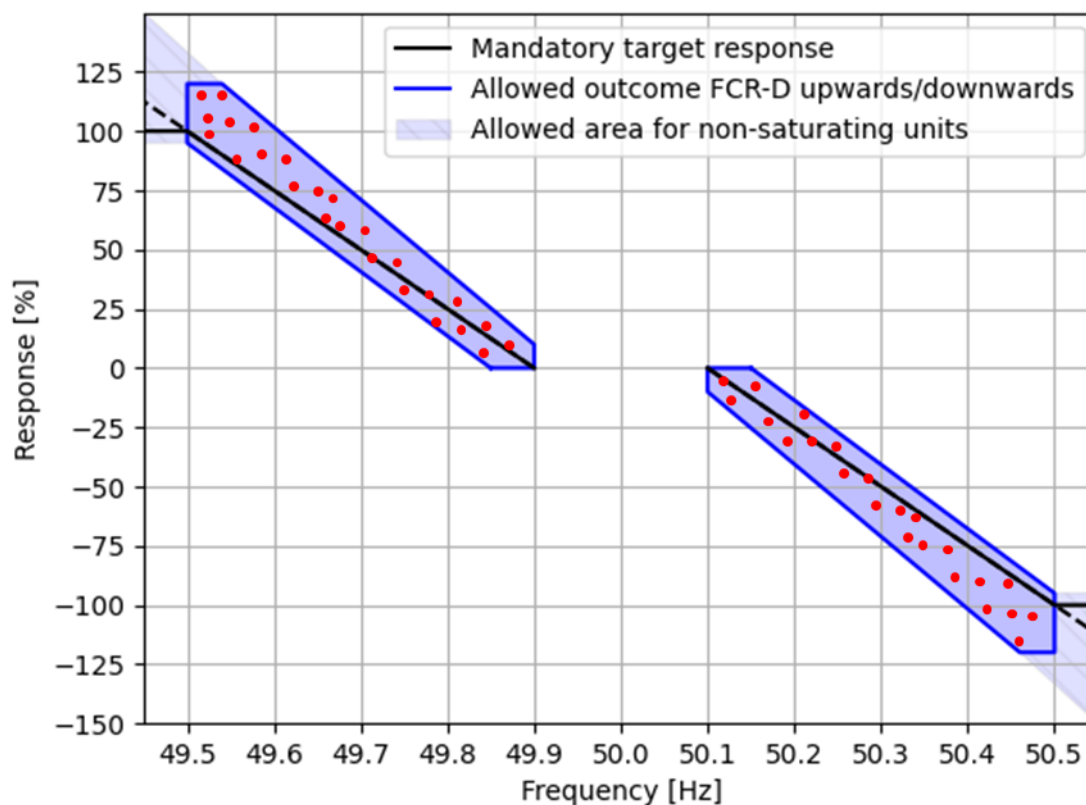

Figure 28. Example response (red dots) of stationary activation of FCR-D upwards and FCR-D downwards for an FCR providing entity, compared to requirement for linearity (blue area).

Table 8. Coordinates of the corners in Figure 28. Counter-clockwise starting from the minimum activation at 49.9 Hz and 50.1 Hz respectively. Left FCR-D upwards regulation, right FCR-D downwards regulation.

Frequency [Hz]	Response [%]	Frequency [Hz]	Response [%]
49.90	0.0	50.10	0.0
49.85	0.0	50.15	0.0
49.50	95	50.50	-95
49.50	120	50.50	-120
49.54	120	50.46	-120
49.90	10	50.10	-10
49.90	0.0	50.10	0.0

4.6 Capacity determination for operational points within the tested interval

The capacity will in general be determined at four operational points, i.e. the four combinations of

$$[\text{maximal setpoint, minimal setpoint, highest droop, lowest droop}] = [sp_{max}, sp_{min}, ep_{max}, ep_{min}],$$

as described in Section 3. The capacities for each operational point are determined by equation (4.13) for FCR-N, equation (4.25) for both FCR-D upwards and FCR-D downwards.

When the maximal capacity ($C_{max}(sp)$), i.e. capacity for the lowest droop (ep_{min}), has been determined for the highest and lowest setpoint in the tests (sp_{max} , sp_{min}), the maximal capacity for any setpoint in between ($C_{max}(sp)$) can be calculated through linear interpolation. Correspondingly the minimal capacity ($C_{min}(sp)$) for any setpoint can be calculated from the minimal capacity for the highest and lowest setpoint. Thus, the maximal capacity (from the lowest droop setting) and the minimal capacity (from the highest droop setting) can be calculated for any setpoint in between the highest and lowest setpoint.

The actual capacity (C) for the operational point is determined not only by setpoint, but also by the droop setting. The capacity for any droop setting $C(ep)$ is determined by linear interpolation of the capacity from the lowest droop (C_{max}) and the capacity from the highest droop (C_{min}), which in turn are interpolated for the setpoint per the previous paragraph. The interpolations are described mathematically in Equation(4.31).

$$\begin{aligned}
 C_{max}(sp) &= C_{max}(sp_{min}) + [C_{max}(sp_{max}) - C_{max}(sp_{min})] \cdot \left[\frac{sp - sp_{min}}{sp_{max} - sp_{min}} \right] \\
 C_{min}(sp) &= C_{min}(sp_{min}) + [C_{min}(sp_{max}) - C_{min}(sp_{min})] \cdot \left[\frac{sp - sp_{min}}{sp_{max} - sp_{min}} \right] \\
 C(ep) &= C_{min} + [C_{max} - C_{min}] \cdot \left[\frac{ep - ep_{min}}{ep_{max} - ep_{min}} \right] \tag{4.31} \\
 C(sp, ep) &= 0, \quad \text{if } \begin{cases} sp > sp_{max} \\ sp < sp_{min} \\ ep > ep_{max} \\ ep < ep_{min} \end{cases}
 \end{aligned}$$

This procedure is valid for both FCR-N and FCR-D. If the entity is tested at more than 2 setpoint values or more than two droop levels, the linear interpolation is done based on the two tested corresponding values in-between which the sought value lies.

The above given set of equations are examples to indicate how the interpolation in general shall be performed. If the equations have to be modified to suit an FCR providing entity this shall be documented in the application and approved by the reserve connecting TSO.

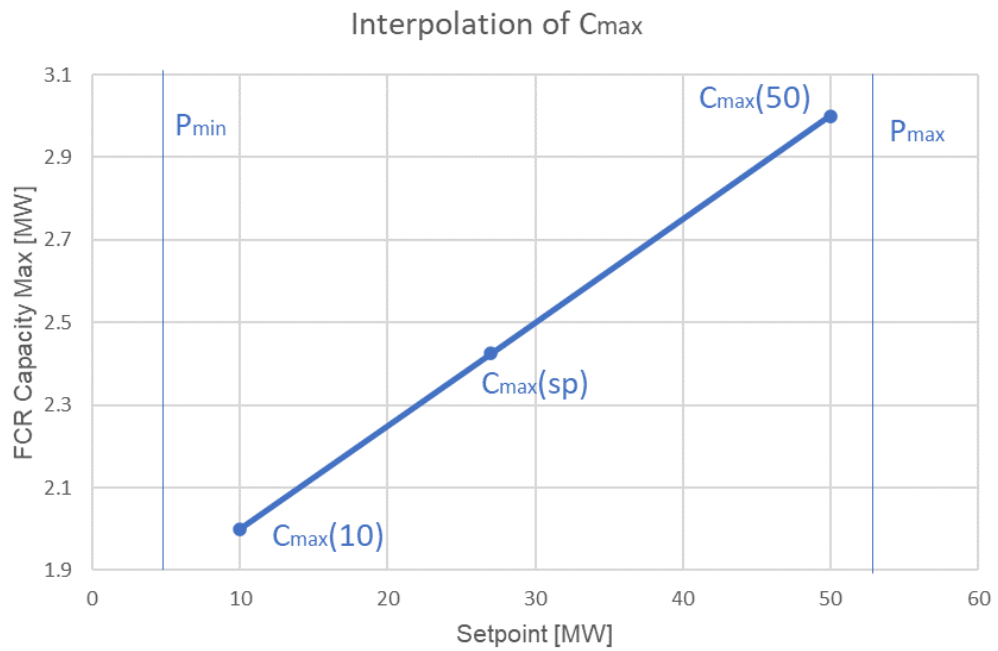

Figure 29. First step of the linear interpolation to determine the maximal capacity for setpoints between the minimum and maximum tested setpoint.

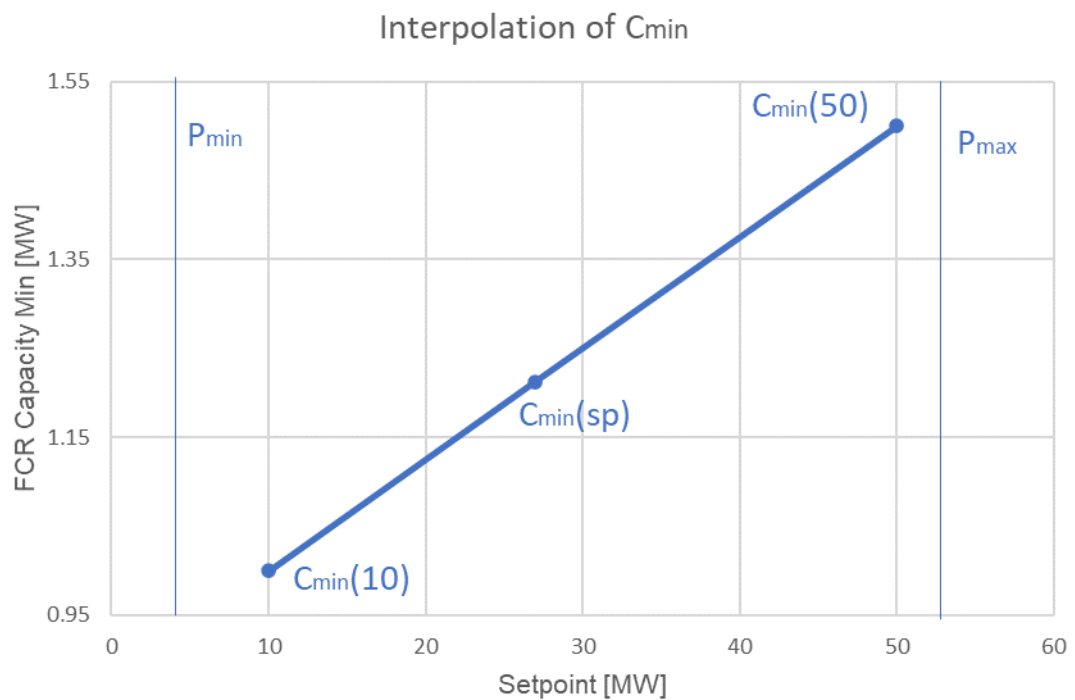

Figure 30. Second step of the linear interpolation to determine the minimal capacity for setpoints between the minimum and maximum tested setpoint.

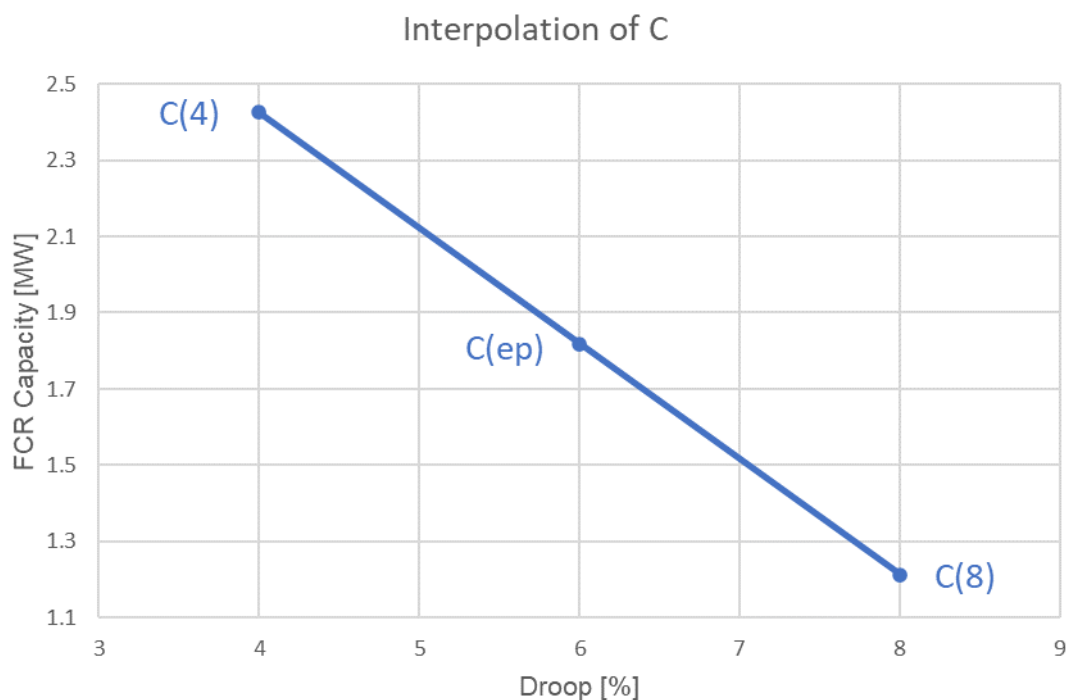

Figure 31. Third step of the linear interpolation to determine the actual capacity for droop levels between the minimum and maximum tested droop.

Once the maximum and minimum capacity are determined for the maximum and minimum setpoint, the prequalified capacities in between can be calculated with Equation (4.31) as shown by the examples below. The tests have in the example been performed for two setpoints, 10 MW and 50 MW, and two droop levels, 4% and 8%. The test results are summarised in Table 9 below. The interpolation is also shown graphically in Figure 29, Figure 30 and Figure 31.

Table 9. Example outcome of testing at four operational points.

Setpoint [MW]	Droop [%]	Capacity [MW]
10	4	2
50	4	3
10	8	1
50	8	1.5

Assume that the capacity shall be calculated if a setpoint of 27 MW and a droop level of 6% are chosen. By application of Equation (4.31):

$$C_{max}(27) = 2 + (3 - 2) \frac{27 - 10}{50 - 10} = 2,425 \text{ MW}$$

$$C_{min}(27) = 1 + (1,5 - 1) \frac{27 - 10}{50 - 10} = 1,2125 \text{ MW}$$

$$C(6) = 1,2125 + (2,425 - 1,2125) \frac{6 - 4}{8 - 4} = 1,82 \text{ MW}$$

4.7 Capacity determination for uncertain or varying responses

The delivered response from an FCR providing entity may be partly uncertain, due to e.g. stochastic or periodic consumption of the entity. The delivered response shall then be calculated as the difference between the active power output after the activation, and the active power output that would have occurred if the entity had remained not activated. This is illustrated for two types of varying loads in Figure 32 and Figure 33.

Example 1 illustrates a situation where the load variations are independent of if the entity has been activated or not. If it is possible to determine that the variations are independent of activation, they will be excluded from the capacity calculation during prequalification and operation. To do this assessment the application has to include suitable data and documentation.

Example 2 illustrates a situation where the variations are not independent of the delivery. In such a case the capacity shall be determined from the response that is ensured, i.e. the minimum of the response curve after activation.

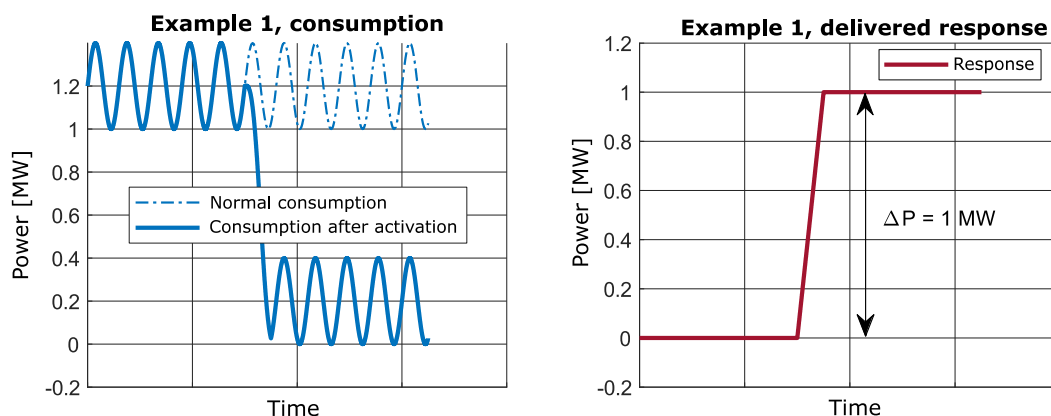

Figure 32. Example response where variations are independent of the delivered response.

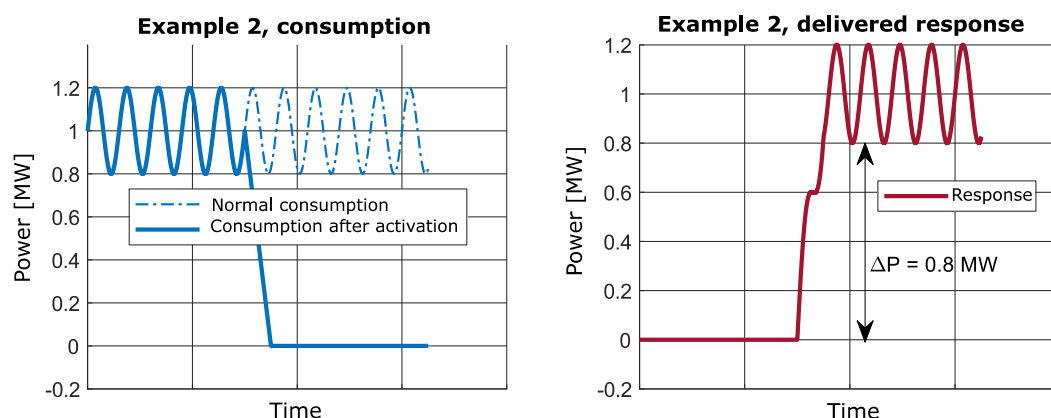

Figure 33. Example response where the variations are not independent of the delivered response.

5 FCR capacity calculation for real-time telemetry and data logging

The TSOs have to be able to monitor the capacity of maintained reserves in real-time in order to ensure operational security and to predict the behaviour of the system. Access to logged data of the reserves enables the TSOs to ensure the quality of the product and precision in disturbance analysis as well as a possibility for providers to optimise their products.

Since maintained FCR capacity may be limited by the maximum power output (and by the minimum power output), the FCR-N and FCR-D capacity, as calculated in subsection 4.6, has to be available for activation. As the FCR capacity can vary with the setpoint and the setpoint may be changed during operation, the maintained capacity of the FCR needs to be recalculated accordingly.

The methods outlined in this section shall be used when calculating the maintained FCR capacity for real-time telemetry and data logging purposes if the provider does not have a more accurate method (the method needs to be approved by the TSO). For aggregated entities, aggregated values shall be reported to the TSO.

5.1 Maintained FCR-N capacity

The maintained FCR-N capacity (MW), $C_{\text{FCR-N,maintained}}$, can be calculated according to

$$C_{\text{FCR-N,maintained}} = \min(P_{\text{max}} - P_{\text{setpoint}}, P_{\text{setpoint}} - P_{\text{min}}, C_{\text{FCR-N}}(sp, ep)) \quad (5.1)$$

where

P_{max} is the current maximum power output

P_{min} is the current minimum power output

P_{setpoint} is the current power setpoint

$C_{\text{FCR-N}}(sp, ep)$ is calculated as in Equation (4.31)

This calculation is illustrated in Figure 34. $C_{\text{FCR-N}}$ is zero when the frequency control is inactive. Note that FCR-N capacity is symmetrical, i.e. equal capacity for up and downwards activation.

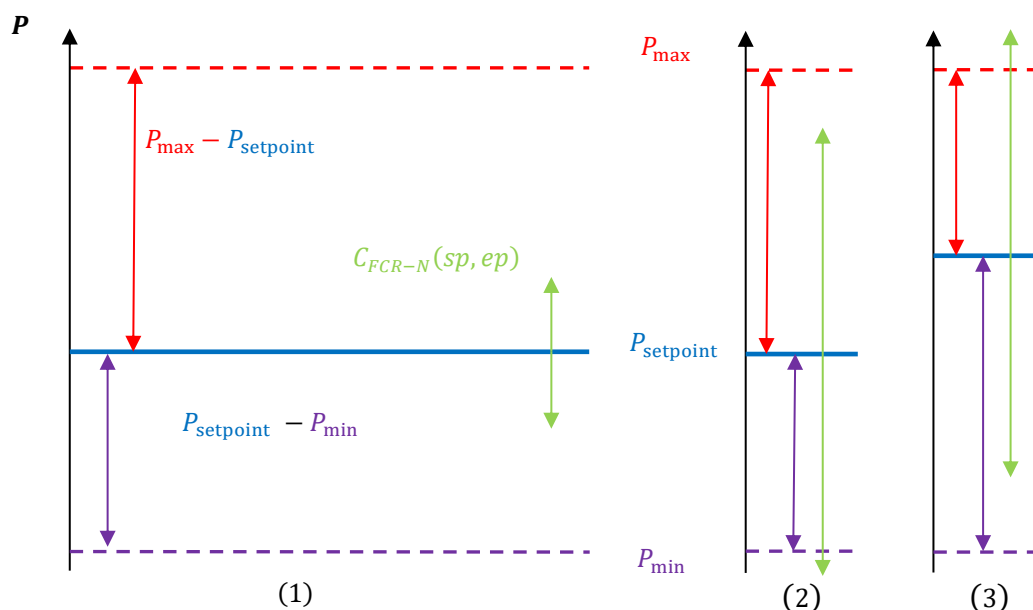

Figure 34. The three limits of FCR-N capacity for a unit which is limited either by prequalification test result (1), minimum active power (2) or maximum active power (3).

5.2 Maintained FCR-D capacity

Maintained FCR-D capacity (MW), separately for upwards and downwards regulation can be calculated according to

$$C_{FCR-D,upwards,maintained} = \max \left[\min \left(P_{\max} - P_{\text{setpoint}} - C_{FCR-N,maintained}, C_{FCR-D,upwards}(sp, ep) \right), 0 \right] \quad (5.2)$$

$$C_{FCR-D,downwards,maintained} = \max \left[\min \left(P_{\text{setpoint}} - P_{\min} - C_{FCR-N,maintained}, C_{FCR-D,downwards}(sp, ep) \right), 0 \right] \quad (5.3)$$

This calculation is illustrated in Figure 35.

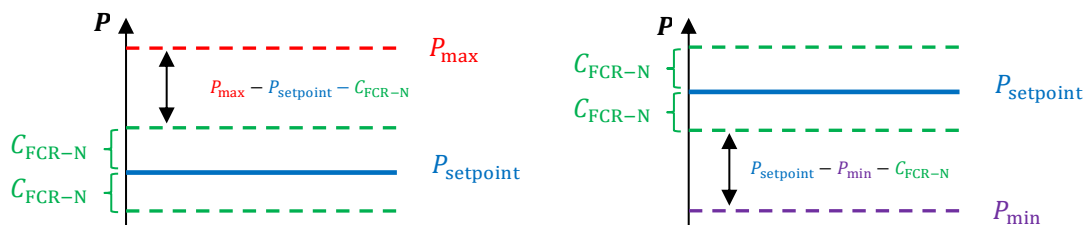

Figure 35. The limits of FCR-D capacity for a unit which is limited either by maximum active power or minimum active power while delivering FCR-N (FCR-D upwards in the left figure and FCR-D downwards in the right).

$C_{FCR-D,upward}$ and/or $C_{FCR-D,downward}$ is zero when the frequency control is inactive. The value of C_{FCR-N} is set to zero for an entity delivering only FCR-D.

5.3 FCR providing entities with limited energy reservoir (LER)

In addition to the maintained capacity, entities with a limited activation capability shall also report the amount of FCR capacity which has limited activation capability.

Endurance of FCR-N capacity with limited activation capability (the time until an entity providing FCR-N is limited) is calculated according to the minimum of

$$L_{FCR-N \text{ endurance,upwards}} = \left| \frac{E_{\text{current reservoir}}}{P_{\text{setpoint}} - P_{\text{reservoir inflow}} + C_{FCR-N}(sp, ep)} \right| \cdot 60 \text{ [minutes]} \quad (5.4)$$

$$L_{FCR-N \text{ endurance,downwards}} = \left| \frac{E_{\text{current reservoir}}}{P_{\text{setpoint}} - P_{\text{reservoir inflow}} + C_{FCR-N}(sp, ep)} \right| \cdot 60 \text{ [minutes]} \quad (5.5)$$

Endurance of FCR-D downwards capacity with limited activation capability is calculated according to

$$L_{FCR-D \text{ endurance,downwards}} = \left| \frac{E_{\text{reservoir max}} - E_{\text{current reservoir}}}{P_{\text{reservoir inflow}} - P_{\text{setpoint}} + C_{FCR-D \text{ downwards}}(sp, ep)} \right| \cdot 60 \text{ [minutes]} \quad (5.6)$$

Endurance of FCR-D upwards capacity with limited activation capability is calculated according to

$$L_{FCR-D \text{ endurance,upwards}} = \left| \frac{E_{\text{current reservoir}} - E_{\text{reservoir min}}}{P_{\text{setpoint}} + C_{FCR-D \text{ upwards}}(sp, ep) - P_{\text{reservoir inflow}}} \right| \cdot 60 \text{ [minutes]} \quad (5.7)$$

where

$E_{\text{reservoir max}}$ is the reservoir current maximum storage threshold/limit [MWh]

$E_{\text{reservoir min}}$ is the reservoir current minimum storage threshold/limit [MWh]

$E_{\text{current reservoir}}$ is the current reservoir level [MWh]

$P_{\text{reservoir inflow}}$ is the current reservoir inflow if applicable [MW]

$L_{FCR-N \text{ endurance}}$ is the current endurance [minutes]

$L_{\text{FCR-D endurance,downwards}}$ is the current endurance [minutes]

$L_{\text{FCR-D endurance,upwards}}$ is the current endurance [minutes]

Note 60 minutes in equations (5.4) to (5.7) is used to convert from hours to minutes.

For FCR providing entities, limited due to something other than reservoir restrictions, the calculations shall be performed in a similar fashion but with modifications to the procedure where applicable.

5.4 Activated FCR capacity calculation

Activated FCR capacity, A_{FCR} , is to be calculated as

$$A_{FCR} = P_{\text{actual}} - P_{\text{setpoint}} - P_{\text{other reserves}} \quad (5.8)$$

where

P_{actual} is the current instantaneous active power

P_{setpoint} is the active power setpoint, corresponding to the output power at 50.00 Hz (including verified control errors)

$P_{\text{other reserves}}$ is the power output of other reserves than FCR not included in the setpoint

6 Appendices

Appendix 1: Determination of operational conditions to perform tests

This appendix contains an example on how to choose the setpoints in order to maximise the prequalified interval of operational conditions for a specific entity. Generally, it is required to complete one test set at a minimum of four operational conditions for FCR-N, FCR-D upwards, and FCR-D downwards:

- 1) *Maximum active power setpoint* where the entity will provide FCR, and *maximum droop*, and corresponding controller parameter sets, where the entity will provide FCR.
- 2) *Maximum active power setpoint* where the entity will provide FCR, and *minimum droop*, and corresponding controller parameter sets, where the entity will provide FCR.
- 3) *Minimum active power setpoint* where the entity will provide FCR, and *maximum droop*, and corresponding controller parameter sets, where the entity will provide FCR.
- 4) *Minimum active power setpoint* where the entity will provide FCR, and *minimum droop*, and corresponding controller parameter sets, where the entity will provide FCR.

The entity is then allowed to deliver also for setpoint in-between the tested setpoint interval, and for droop levels within the tested droop interval, with capacities interpolated in accordance with subsection 4.6.

Below follows an example based on a production unit that shall prequalify for FCR-N, FCR-D upwards and FCR-D downwards. The unit is able to individually control each product and the aim is to maximise the interval for which the unit is qualified to operate in.

Table 10. Properties of the example production unit.

Property	Quantity	Unit
P_{\max}	50.0	MW
P_{\min}	5.0	MW

Table 11. Expected capacities for the example unit, prior to testing.

Capacity	Max	Min
C_{FCR-N}	5 MW	1 MW
$C_{FCR-D Up}$	10 MW	4 MW
$C_{FCR-D Down}$	10 MW	4 MW

The operational test points to apply during the test are calculated as in Table 13, Table 14, and Table 15 on the following pages. The tables contain columns that is to be interpreted as follows:

Table 12. List of definitions for Table 13, Table 14, and Table 15.

Test ID	Suggested designation for each individual test.
Test type	The type of test to perform.
Capacity	Capacity (droop) to apply during the test, i.e. max/min.
Operational point	Setpoint to apply during the test, i.e. max/min.
P extreme	The most extreme set point that can be used, to maximise prequalified setpoint interval.
P chosen	Same as P extreme, but with some margin added for testing. The TSOs recommend the provider to add a suitable amount of margin to ease testing, dependent on the size of the resource, technology, etc.
Equation	The equation used to calculate P extreme.
Corresponding frequency	The baseline frequency that the test is starting from and for which P extreme/chosen is valid for.
Section in main document	The corresponding section in the main document where the specific test is introduced.

Table 13. FCR-N

Test ID	Test type	Capacity	Operational point	P extreme [MW]	P chosen [MW]	Equation	Corresponding frequency	Section in main document
1.1	Step	C_{min}	sp_{min}	6	7	$P_{min} + C_{min}$	50 Hz	4.4.1
1.2	Step	C_{max}	sp_{min}	10	11	$P_{min} + C_{max}$	50 Hz	4.4.1
1.3	Step	C_{min}	sp_{max}	49	48	$P_{max} - C_{min}$	50 Hz	4.4.1
1.4	Step	C_{max}	sp_{max}	45	44	$P_{max} - C_{max}$	50 Hz	4.4.1
1.5	Sine	C_{min}	sp_{max}	49	48	$P_{max} - C_{min}$	50 Hz	4.4.2
1.6	Sine	C_{max}	sp_{max}	45	44	$P_{max} - C_{max}$	50 Hz	4.4.2
1.7	Linearity	C_{min}	sp_{min}	6	7	$P_{min} + C_{min}$	50 Hz	4.4.3
1.8	Linearity	C_{max}	sp_{max}	45	44	$P_{max} - C_{max}$	50 Hz	4.4.3
1.9	Active control	C_{max}	Free to choose	10-45	11-44	-	50 Hz	4.7

Table 14. FCR-D upwards

Test ID	Test type	Capacity	Operational point	P extreme [MW]	P chosen [MW]	Equation	Corresponding frequency ⁵	Section in main document
2.1	Stationary performance	C_{min}	sp_{min}	5	6	P_{min}	49.9 Hz	4.5.1
2.2	Stationary performance	C_{max}	sp_{min}	5	6	P_{min}	49.9 Hz	4.5.1
2.3	Stationary performance	C_{min}	sp_{max}	46	45	$P_{max} - C_{min}$	49.9 Hz	4.5.1
2.4	Stationary performance	C_{max}	sp_{max}	40	39	$P_{max} - C_{max}$	49.9 Hz	4.5.1
2.5	Ramp	C_{min}	sp_{min}	5	6	P_{min}	49.9 Hz	4.5.2
2.6	Ramp	C_{max}	sp_{min}	5	6	P_{min}	49.9 Hz	4.5.2
2.7	Ramp	C_{min}	sp_{max}	46	45	$P_{max} - C_{min}$	49.9 Hz	4.5.2
2.8	Ramp	C_{max}	sp_{max}	40	39	$P_{max} - C_{max}$	49.9 Hz	4.5.2
2.9	Sine	C_{min}	sp_{max}	45	44	$P_{max} - C_{min}/2$	49.7 Hz	4.5.5
2.10	Sine	C_{max}	sp_{max}	48	47	$P_{max} - C_{max}/2$	49.7 Hz	4.5.5
2.11	Logged data	C_{max}	Free to choose	5-40	6-39	-	49.9 Hz	4.7

⁵ For entities not testing switchover from FCR-N. In that case 50.0 Hz and 49.9 Hz gives the same output for the FCR-D upwards controller. If switchover is included corresponding activation capability shall be left to also activate FCR-N, and qualified setpoint interval thus adjusted.

Table 15. FCR-D downwards

Test ID	Test type	Capacity	Operational point	P extreme [MW]	P chosen [MW]	Equation	Corresponding frequency ⁶	Section in main document
3.1	Stationary performance	C_{min}	sp_{min}	9	10	$P_{min} + C_{min}$	50.1 Hz	4.5.3
3.2	Stationary performance	C_{max}	sp_{min}	9	10	$P_{min} + C_{max}$	50.1 Hz	4.5.3
3.3	Stationary performance	C_{min}	sp_{max}	50	49	P_{max}	50.1 Hz	4.5.3
3.4	Stationary performance	C_{max}	sp_{max}	50	49	P_{max}	50.1 Hz	4.5.3
3.5	Ramp	C_{min}	sp_{min}	9	10	$P_{min} + C_{min}$	50.1 Hz	4.5.4
3.6	Ramp	C_{max}	sp_{min}	9	10	$P_{min} + C_{max}$	50.1 Hz	4.5.4
3.7	Ramp	C_{min}	sp_{max}	50	49	P_{max}	50.1 Hz	4.5.4
3.8	Ramp	C_{max}	sp_{max}	50	49	P_{max}	50.1 Hz	4.5.4
3.9	Sine	C_{min}	sp_{max}	48	47	$P_{min} + C_{min}/2$	50.3 Hz	4.5.5
3.10	Sine	C_{max}	sp_{max}	45	44	$P_{min} + C_{max}/2$	50.3 Hz	4.5.5
3.13	Logged data	C_{max}	Free to choose	9-50	10-49	-	50.1 Hz	4.7

⁶ For entities not testing switchover from FCR-N. In that case 50.0 Hz and 50.1 Hz gives the same output for the FCR-D upwards controller. If switchover is included corresponding activation capability shall be left to also activate FCR-N, and qualified setpoint interval thus adjusted.

Appendix 2: Different graphical representations of FCR dynamic requirements

A method for illustrating the FCR providing entity response, is the FCR-vectors. This uses calculations equivalent to those specified in Subsection 4.1, but with a differing graphical presentation.

Figure 36 illustrates how the transfer function values can be visualized as FCR-vectors. The FCR-vectors are plotted in a complex plane having an imaginary axis (y) and a real axis (x). The vectors always start from the origin, point (0, 0). The length of the vector equals the gain of the corresponding transfer function value and the angle of the vector equals the phase of the corresponding transfer function value.

Alternatively, FCR-vectors can be defined by the (x, y)-coordinates of their end points. The x-coordinate (real part of the transfer function value) can be calculated from the gain and phase of the transfer function value as

$$x = |F(j\omega)| \cos [\text{Arg}(F(j\omega))] \quad (\text{A2.1})$$

and the y-coordinate (imaginary part of the transfer function value) can be calculated as

$$y = |F(j\omega)| \sin [\text{Arg}(F(j\omega))] \quad (\text{A2.2})$$

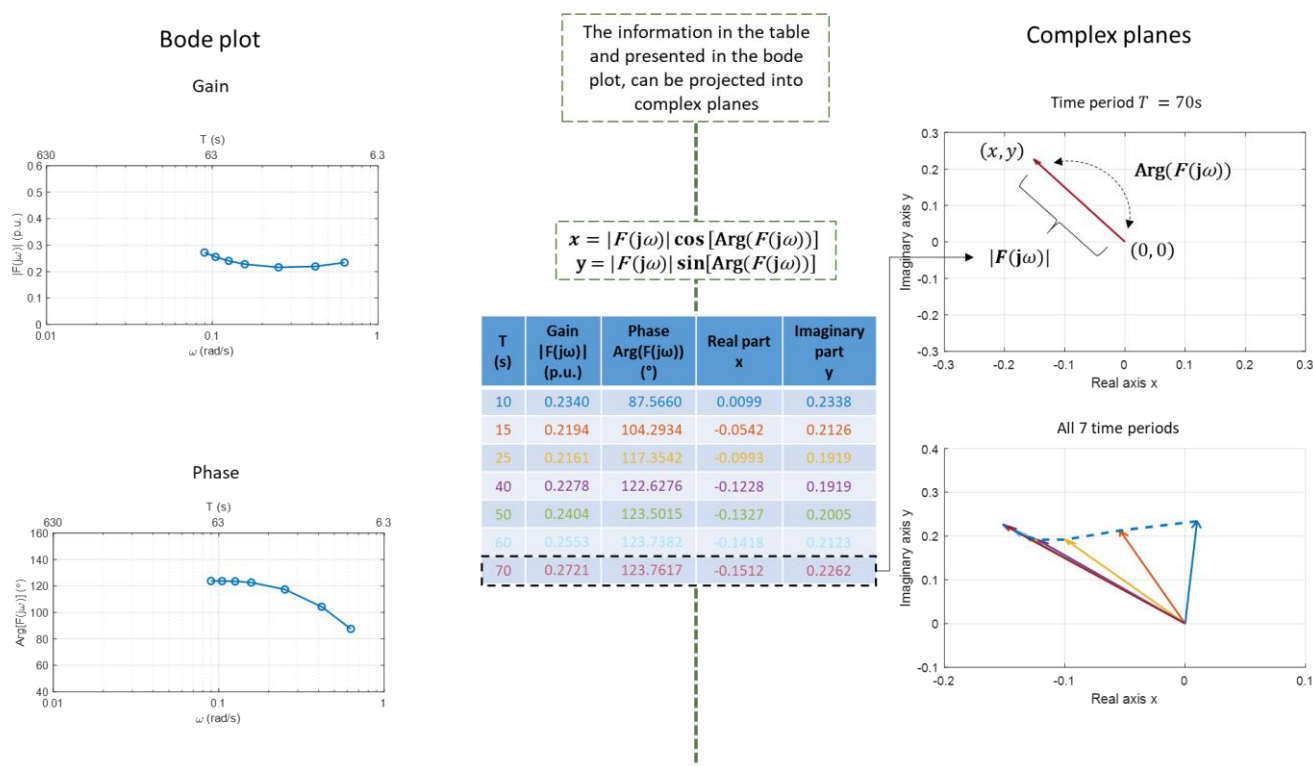

Figure 36. Bode plots, transfer function values, FCR-vectors and complex planes

The requirement circles (dynamic performance and stability) can be plotted in the same complex planes. This way of visualizing the requirement may be helpful when tuning the controller.

The FCR-N dynamic performance requirement is met when all the FCR-vectors point outside the pre-defined performance requirement circles. The performance requirement circle centre coordinates and the

circle radiuses are listed in Table 16. The circles are visually represented in Figure 37 together with the FCR-vectors of an example entity.

The circles are only indicative and the final verification of the dynamic performance has to be performed using the diagram shown in the Main document. FCR-vectors pointing outside the circles only guarantee that the requirement is met at the corresponding discrete time periods, whereas the dynamic performance requirement is continuous in between time periods from 10 s to 70 s.

Table 16. Centre coordinates and radiuses for FCR-N dynamic performance requirement circles

Time period (s)	Circle centre (x, y)⁷	Circle radius (p.u.)
10	(0.070, 0.796)	0.023
15	(0.070, 0.531)	0.034
25	(0.070, 0.318)	0.057
40	(0.070, 0.199)	0.091
50	(0.070, 0.159)	0.113
60	(0.070, 0.133)	0.135
70	(0.070, 0.114)	0.157

⁷ where x corresponds to the real part and y corresponds to the imaginary part

The stability margin is sufficient when all the FCR-vectors point outside the pre-defined stability requirement circles. The FCR-N stability circle-centre coordinates and circle radii are listed in Table 17. For FCR-D, the radii of the stability circles may vary according to the FCR-D performance scaling. The FCR-N stability requirement circles are visually represented in Figure 37 together with the FCR-vectors of an example entity.

The circles are only indicative and final stability verification has to be performed using a Nyquist diagram. FCR-vectors pointing outside the circles only guarantee that the stability margins are sufficient at discrete time periods, not that the system is stable. Hence, it is possible to have an unstable system even though the FCR-vectors are pointing outside the stability circles. Also, the stability requirement is continuous, not discrete. Therefore, the stability requirement verification using Nyquist diagram is needed.

Table 17. Centre-coordinates and radiuses of FCR-N stability requirement circles

Time period [s]	Circle centre (x, y)⁸ [p.u., p.u.]	Circle radius [p.u.]
10	(0.019, 0.503)	0.218
15	(0.019, 0.335)	0.145
25	(0.019, 0.201)	0.087
40	(0.019, 0.126)	0.055
50	(0.019, 0.101)	0.044
60	(0.019, 0.084)	0.037
70	(0.019, 0.072)	0.032

The 5 % measurement uncertainty tolerance used when evaluating the compliance has not been included in the values presented in Table 16 and Table 17, nor in Figure 37.

⁸ where x corresponds to the real part and y corresponds to the imaginary part

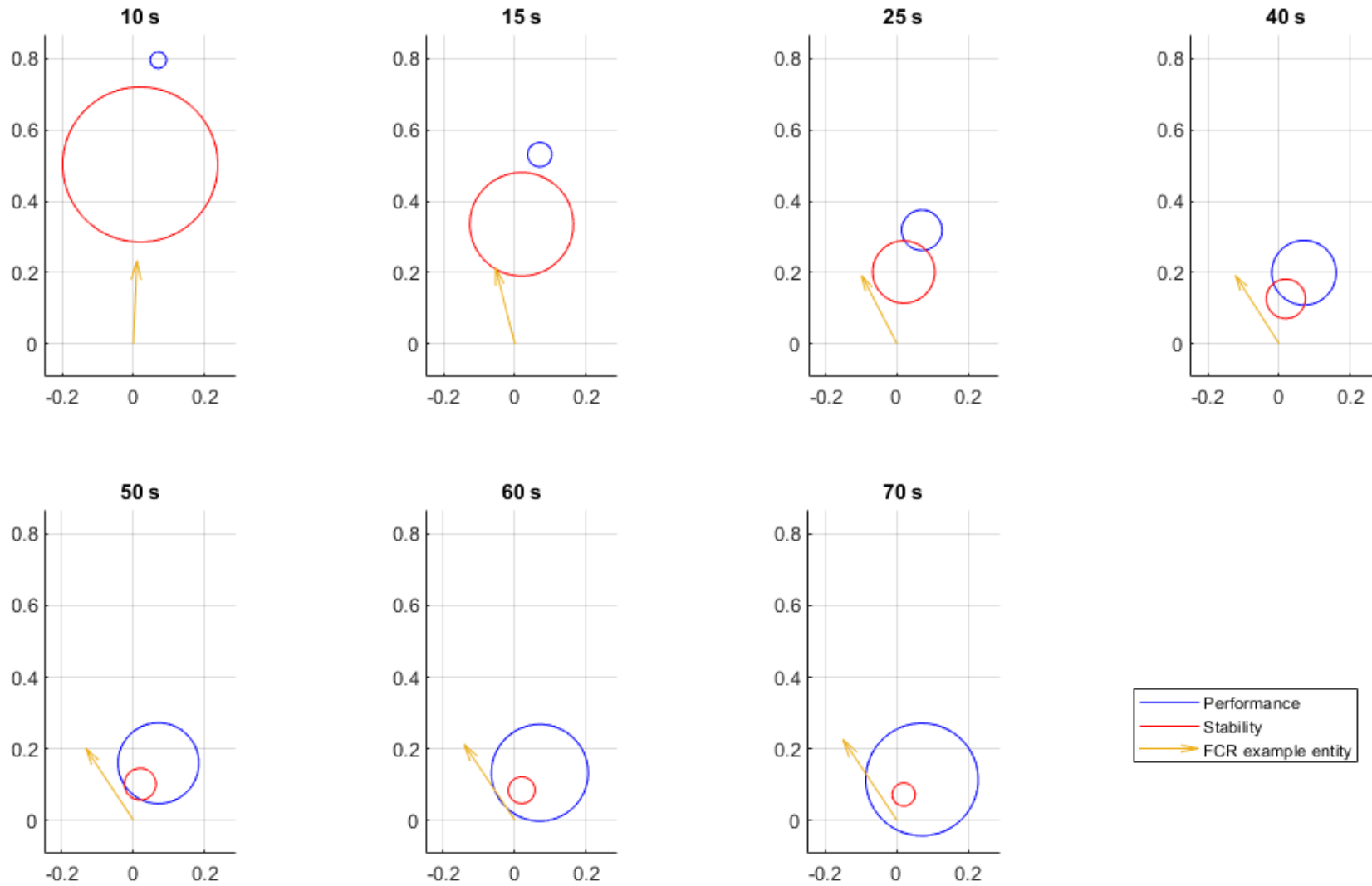

Figure 37. FCR-N dynamic performance & stability requirement circles and FCR-vectors of an example entity

Supporting Document on
Technical Requirements for
Frequency Containment Reserve Provision in
the Nordic Synchronous Area
